

# INTEGRA



**EVOLVE Manual Pipettes**

**Operating instructions**

# INTEGRA Declaration of conformity

**INTEGRA Biosciences Corp. – Hudson, NH, USA**

declares on its own responsibility that the devices

Description	Models
<b>EVOLVE Manual Pipettes</b>	<b>3011, 3012, 3013, 3015, 3016, 3018, 3019, 3022, 3024, 3025, 3026, 3032, 3034, 3035, 3036</b>

comply with:

<b>EU Directives</b> (DoW: Date of Withdrawal)	Before DoW	DoW	After DoW
Restriction of Hazardous Substances	<b>2011/65/EU</b>		

## **EU Regulations**

Registration, Evaluation, Authorisation and Restriction of Chemicals (REACH)	<b>1907/2006</b>
--	------------------

## **International Standards**

Piston-operated volumetric apparatus - Part 2: Piston pipettes	<b>ISO 8655-2</b>
--	-------------------

Hudson, New Hampshire, USA - August 11, 2016



George Kalmakis  
VP Operations

## Table of Contents

<b>Chapter 1</b>	<b>Introduction</b>	
	1.1 Symbols used.....	5
	1.2 Intended use.....	5
	1.3 Safety notes .....	6
<b>Chapter 2</b>	<b>Description of the device</b>	
	2.1 Scope of delivery .....	7
	2.2 Overview of the EVOLVE Manual Pipettes .....	7
<b>Chapter 3</b>	<b>Installation</b>	
	3.1 Optional color coded plunger cap.....	8
	3.2 Changing the Plunger Spring .....	8
<b>Chapter 4</b>	<b>Operation</b>	
	4.1 Setting the volume.....	10
	4.2 Attaching and removing GripTip pipette tips .....	10
	4.3 Pipetting .....	11
	4.3.1 Aspirating and Dispensing .....	11
	4.3.2 Reverse mode.....	12
	4.3.3 Proper pipetting techniques .....	13
	4.4 Troubleshooting.....	14

**Chapter 5 Maintenance**

5.1	Cleaning .....	15
5.2	Single channel lower end disassembly .....	15
	5.2.1 Disassembly.....	15
	5.2.2 Reassembly .....	18
5.3	Sterilization .....	20
	5.3.1 Autoclaving the disassembled components.....	20
5.4	Servicing.....	21
	5.4.1 Shipping to INTEGRA Biosciences.....	21
	5.4.2 Changing O-rings of tip fittings.....	21
	5.4.3 Lubrication .....	22
5.5	Calibration .....	23
	5.5.1 Materials .....	23
	5.5.2 Definitions .....	23
	5.5.3 Test conditions and environment.....	24
	5.5.4 Pre-wetting of tips .....	24
	5.5.5 Leak test .....	25
	5.5.6 Obtaining the actual volume .....	26
	5.5.7 Calculation of accuracy and precision .....	27
	5.5.8 Adjusting EVOLVE Manual Pipettes.....	28
5.6	Equipment disposal .....	29

**Chapter 6 Technical Data**

6.1	Environmental conditions .....	30
6.2	Pipette specifications.....	30
6.3	Z Correction Factors.....	32

**Chapter 7 Accessories and Consumables**

7.1	Accessories .....	33
7.2	Consumables .....	33

<b>Imprint.....</b>	<b>36</b>
---------------------	-----------

# 1 Introduction

These operating instructions contain all the information required for installation, operation and maintenance of the EVOLVE Manual Pipettes. This chapter informs about the symbols used in these operating instructions, the intended use of the EVOLVE Manual Pipettes and the general safety instructions.

## 1.1 Symbols used

The operating instructions specifically advise of residual risks with the following symbols:

**WARNING**

*This safety symbol warns against hazards that could result in injury. It also indicates hazards for machinery, materials and the environment. It is essential that you follow the corresponding precautions.*

**CAUTION**

*This symbol cautions against potential material damage. Follow the instructions.*

**NOTE**

*This symbol identifies important notes regarding the correct operation of the device and labor-saving features.*

## 1.2 Intended use

This is a general-purpose laboratory instrument for use in research only. Any use of this instrument in a medical or IVD setting is the responsibility of the user.

EVOLVE Manual Pipettes are intended to be used in a laboratory for aspirating and dispensing liquids in the volume range of 0.2–5000 µl using GripTip pipette tips.

### 1.3 Safety notes

EVOLVE Manual Pipettes comply to the recognized safety regulations and is safe to operate. EVOLVE Manual Pipettes can only be operated when in perfect condition and while observing these operating instructions.

The device may be associated with residual risks if it is used or operated improperly by untrained personnel. Any person operating the EVOLVE Manual Pipettes must have read and understood these operating instructions, and particularly, the safety notes, or must have been instructed by supervisors so that safe operation of the device is guaranteed.

**WARNING**

*When handling dangerous substances, comply with the material safety data sheet (MSDS) and with all safety guidelines such as the use of protective clothing and safety goggles.*

**CAUTION**

- *Do not immerse the EVOLVE Manual Pipettes in liquid. The fluid can damage internal parts. Avoid pipetting of liquids whose vapors could attack the materials PA (polyamide), POM (polyoxymethylene), FPM (fluor-rubber), NBR (nitrile-rubber), CR (chloroprene), silicone. Corrosive vapors could also damage metallic parts inside the device.*
- *Repairs may only be performed by INTEGRA Biosciences AG or by an authorized after-sales service member.*
- *Parts may be replaced with original INTEGRA Biosciences parts only.*

**NOTE**

*Prolonged exposure of the EVOLVE Manual Pipettes to UV-light can cause discoloration and/or yellowing of the pipette housing. However, this will not affect the performance of the device in any way.*

Regardless of the listed safety notes, additional applicable regulations and guidelines of trade associations, health authorities, trade supervisory offices, etc. must be observed.

Please visit our website [www.integra-biosciences.com](http://www.integra-biosciences.com) on a regular basis for up to date information regarding REACH classified chemicals contained in our products.

## 2 Description of the device

### 2.1 Scope of delivery

- EVOLVE Manual Pipette
- Multipurpose Tool
- Replacement Plunger Cap
- Quick Start Guide
- Replacement O-rings (for 200 µl, 1000 µl and 5000 µl models)

### 2.2 Overview of the EVOLVE Manual Pipettes



- 1 **Plunger Cap**
- 2 **Plunger**, to pipette
- 3 **Tip Ejector**
- 4 **Finger Hook**
- 5 **Adjustment Dials**, to set volume
- 6 **Volume Window**



The color of the volume indicator label matches GripTip box insert

- 7 **Ejector Sleeve**
- 8 **Tip Fitting**

### 3 Installation

#### 3.1 Optional color coded plunger cap

If desired, replace black plunger cap with optional color coded plunger cap.

#### 3.2 Changing the Plunger Spring

The plunger spring installed inside the pipette is the light spring option. You can exchange with a heavier plunger spring to achieve more control of the plunger movement.

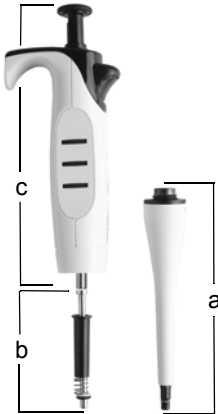

- 1) Unscrew the **Cylinder Assembly** (a) and separate the **Piston Assembly** (b, models 2–200  $\mu$ l) or **Piston** (model 1000  $\mu$ l) from the upper part of the pipette (c). It is held in place by a small magnet.



**NOTE**

5000  $\mu$ l piston and cylinder assembly is removed as one piece.

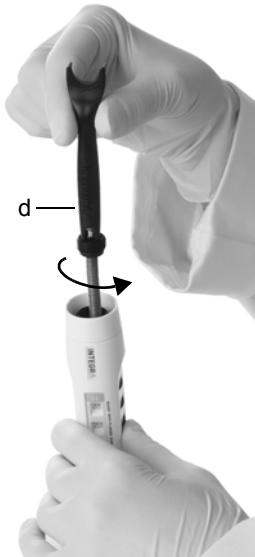

- 2) Set the pipette to the maximum setting. The maximum setting is higher than the maximum volume.
- 3) Put the two teeth of the Multipurpose Tool (d) vertically into the slots of the black opening inside at the bottom of the pipette's body (c). Rotate counterclockwise until the plunger spring assembly (e) is released.





- 4) To install the optional spring assembly, screw the plunger spring assembly (e) clockwise into the upper part of the pipette using the Multipurpose Tool.
- 5) Re-attach the Piston assembly/Piston. Screw clockwise to attach the Cylinder Assembly (a) to the body of the pipette.



**CAUTION**

Validate or calibrate your pipette after reassembly.

## 4 Operation

### 4.1 Setting the volume

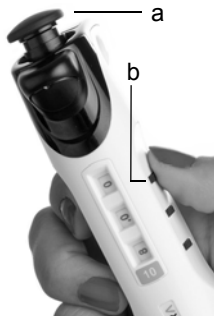

- 1) To set the desired pipetting volume press down the **Plunger** (a) and rotate slightly clockwise to unlock the volume dials.
- 2) Spin the **Adjustment Dials** (b) until the desired volume is shown in the Volume Window.
- 3) Slightly rotate and slowly release the **Plunger** (a) to lock the volume.

### 4.2 Attaching and removing GripTip pipette tips



#### CAUTION

To ensure optimal performance of your EVOLVE Manual Pipettes always use GripTips of correct size which have been designated for the use with the EVOLVE Manual Pipettes, see [“7.2 Consumables” on page 33](#).

The unique GripTip system of the EVOLVE Manual Pipettes reduces attachment and ejection forces, ensures a perfect fitting to prevent the tips from falling off and to provide a perfect seal. On a multichannel pipette all tips sit on the same height.



A rim inside the GripTips snaps over the multi-lobes and ensures firm attachment of the tips.

A shoulder provides a positive stop to prevent over tightening of the tips. Without hammering, the tip is either on or off but nothing in between.

O-ring provides forgiving and robust seal surface for the pipette tip.

#### Attach the tips:

When loading tip(s), press the pipette into the appropriate GripTip(s) until you hear and feel a click indicating that a seal has been achieved. Once you feel the click, stop applying pressure. When loading GripTip pipette tips using a multichannel pipette, slowly rock the pipette from one side to the other side to ensure the proper seal is achieved.

#### Discard your used tips:

If liquid is in the tips, empty them by pressing down the **Plunger** (2) to the second stop (see section [4.3](#)). Tips are easily removed by pressing the **Tip Ejector** (3).

### 4.3 Pipetting

The Plunger can be pushed down to two different stops:

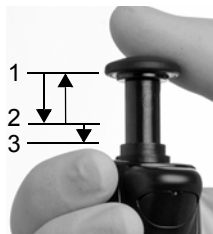

- 1) Top position: Varies depending on volume setting.
- 2) First stop: Fixed calibrated position for aspirating and dispensing.
- 3) Second Stop: To blowout the residual liquid.

For detailed recommendations for pipetting see also [“4.3.3 Proper pipetting techniques”](#) on page 13.

#### 4.3.1 Aspirating and Dispensing

To aspirate and dispense liquid perform the following steps:

##### Aspirate

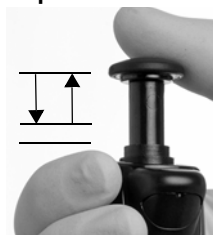

- 1) With GripTip(s) attached, push down the **Plunger** (2) to the first stop.
- 2) Place GripTips in liquid. Hold the pipette vertically or in an angle of max. 20° throughout the entire pipetting process and immerse the GripTip(s) just below the surface of the liquid (2–3 mm).
- 3) Slowly return **Plunger** to the top position. For higher volumes (>200 µl), follow the liquid level by moving the pipette down.
- 4) Remove the GripTip(s) from liquid.

##### Dispense

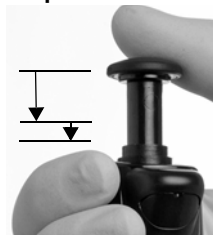

- 5) To dispense the liquid, push the **Plunger** (2) down to the first stop.
- 6) If there is any residual liquid in tip, a blowout should be performed by pressing the **Plunger** to the second stop.
- 7) Remove the GripTips from vessel and release **Plunger**.

### 4.3.2 Reverse mode

Viscous samples should be aspirated and dispensed at slower speeds and in reverse pipetting mode:

#### Aspirate

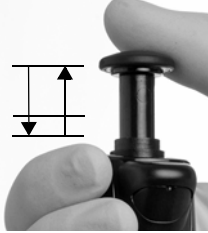

- 1) Fully push down the **Plunger** (2) to the second stop.
- 2) Immerse the GripTip(s) in the liquid, let the **Plunger** slowly release to the upper position and wait shortly until the liquid is fully aspirated.

#### Dispense

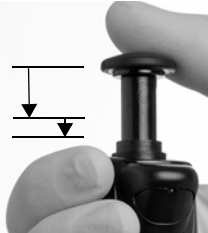

- 3) To dispense, press the **Plunger** (2) slowly down to the first stop and wait a few seconds to dispense the liquid.
- 4) Remove the GripTip(s) from the target vessel.
- 5) To expel the excess liquid press the **Plunger** to the second stop.

### 4.3.3 Proper pipetting techniques

INTEGRA Biosciences recommends the following techniques for enhancing pipetting results. These techniques are consistent with ISO standard 8655-2.

- It is best to immerse the GripTips just below the surface of the liquid (2–3 mm) to allow the desired volume to be aspirated. If the tip is immersed too deep, the risk of carry-over is increased due to liquid drops clinging to the outer surface of the tip.
- Press and release the plunger with consistent speed and smoothness.
- Always prewet GripTips. After loading tips onto your pipette, aspirate and dispense the full volume 2-3 times to coat the inside of pipet tips. Pre-wetting ensures that the liquid and air inside the tips are at equal temperature and the dead air space is humidified. Neglecting to perform a pre-wet can result in a smaller delivery volume in the first few dispenses.
- EVOLVE Manual Pipettes are air displacement pipettes. To properly dispense liquids, ensure that the pipette tip is at a 0–20° angle. After each dispense, you must touch GripTips against the vessel wall or liquid. This process is referred to as “touching off” or “tip touch” and prevents liquid from clinging to the pipette tips.
- Air displacement pipettes show the best performance between 35% and 100% of the nominal volume.
- Viscous samples should be aspirated and dispensed at slowest speeds to ensure accurate pipetting. In addition, pipetting should be performed in a reverse mode.
- For pipetting liquids with high vapor pressures (such as methanol or ethanol), use relatively fast pipetting speeds and avoid prolonged pauses after aspiration.
- Calibrate based on fluid type. EVOLVE Manual Pipettes are tested and calibrated at the factory for use with distilled water at room temperature. It may be necessary to re-calibrate your EVOLVE Manual Pipettes if the liquid to be used has different physical properties (specific gravity and vapor pressure) than water.



#### **WARNING**

*Avoid pipetting for extended periods. To minimize the risk of repetitive strain injury, include pauses of several minutes.*

*Use filtered GripTips to pipette corrosive or biohazardous liquids. The filter prevents vapors and aerosols from corroding or contaminating the cylinder assembly.*

## 4.4 Troubleshooting

<b>Problem</b>	<b>Probable cause</b>	<b>Remedy</b>
Leaking.	<ul style="list-style-type: none"> <li>• Tip incorrectly attached.</li> <li>• Foreign particles between tip and tip fitting.</li> <li>• Damaged red O-ring.</li> </ul>	<ul style="list-style-type: none"> <li>• Attach a new tip.</li> <li>• Clean tip fitting. Attach new tips.</li> <li>• Change the O-ring, see <a href="#">5.4.2</a>.</li> <li>• If leak persists, contact service.</li> </ul>
Dispense results are inaccurate.	<ul style="list-style-type: none"> <li>• Unsuitable calibration for liquid class.</li> <li>• Improper pipetting techniques.</li> </ul>	<ul style="list-style-type: none"> <li>• Recalibrate with the liquids in question.</li> <li>• Adjust aspiration and dispense speed depending on liquid:               <ul style="list-style-type: none"> <li>- High viscosity liquids may require calibration.</li> <li>- High vapor pressure liquids may require pre-wetting.</li> <li>- Refer to proper pipetting techniques section <a href="#">4.3.3</a></li> </ul> </li> </ul>
Not dispensing/ aspirating.	<ul style="list-style-type: none"> <li>• Piston stuck or not connected.</li> <li>• Internal seal is damaged.</li> </ul>	<ul style="list-style-type: none"> <li>• Contact service.</li> </ul>
Droplets on the tips.	<ul style="list-style-type: none"> <li>• Temperature of liquid differs from that of air inside the tips.</li> <li>• Liquid of low viscosity and high vapor pressure.</li> <li>• Touch off was not performed.</li> </ul>	<ul style="list-style-type: none"> <li>• Pre-wet tips up to 3 times.</li> <li>• Increase dispensing speed.</li> <li>• Perform a touch-off.</li> </ul>

## 5 Maintenance

### 5.1 Cleaning

The materials used on the exterior of the EVOLVE Manual Pipettes support regular cleaning intervals. Clean the external components with a lint-free cloth lightly soaked with mild soap solution in distilled water or with a 70 % dilution of Isopropyl or Ethanol. Never use acetone or other solvents.

**WARNING**

*Do not immerse the entire pipette into a cleaning solution or spray cleaning solution directly onto the exterior body of the pipette.*

If the pipette is exposed to corrosive vapors, e.g. from concentrated acids, or if liquid enters the internals, disassemble the lower part of the pipette and clean the internal parts with distilled water or with a 70 % dilution of Isopropyl or Ethanol. Follow the instructions below for disassembly, also necessary for trouble shooting and autoclaving.

### 5.2 Single channel lower end disassembly

#### 5.2.1 Disassembly

Disassemble the lower part of the single channel pipette as follows:

**Models of all sizes:**

- 1) Unscrew counterclockwise to remove the **Cylinder Assembly (a)** from the pipette.
- 2) Slide the **Cylinder Assembly (a)** down from the pipette body. This exposes the **Piston Assembly (b, models 2–200 µl)** or **Piston with mounted Cup Seal (m, model 1000 µl)**.

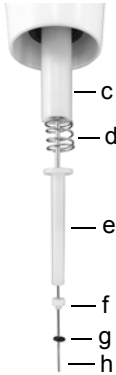

**Models 2–20 µl:**

3) Slide the following components from the Piston (h):

- **O-Ring (black, g) and Seal (white, f) Assembly**
- **Lower Seal Retainer (white, e)**
- **Seal Retainer Spring (d)**
- **Seal Retainer (white, c)**

Set these components aside or place them in an autoclave pouch.

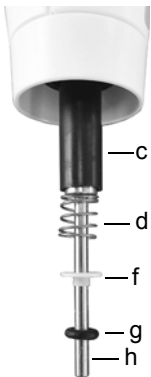

100 µl

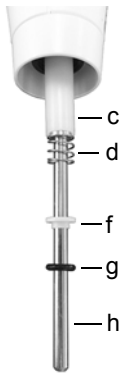

200 µl

**Models 100 µl and 200 µl:**

3) Slide the following components from the Piston (h):

- **O-Ring (black, g) and Seal (white, f) Assembly**
- **Seal Retainer Spring (d)**
- **Seal Retainer (black or white, c)**

Set these components aside or place them in an autoclave pouch.



**Models 2–1000 µl:**

4) Separate the **Piston (h)** from the upper part of the pipette. The **Piston** is held in place by a small magnet.

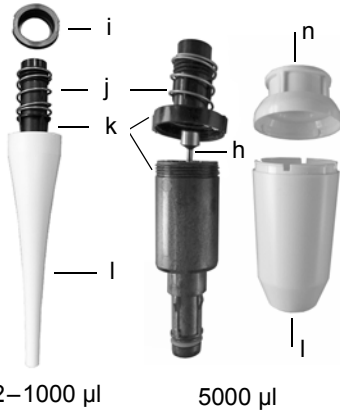

**Cylinder Assemblies (a):****Models 2–1000 µl:**

- 5) With the **Cylinder Assembly (a)** in hand, turn counterclockwise to remove the black **Snap Ring (i)**. Pullout the black **Cylinder (k)** from the white **Ejector Sleeve (l)**.

**Model 5000 µl:**

- 5) Put your fingernails into the gap of the white **Ejector Sleeve (l)** and pull off the **Ejector Sleeve Cap (n)**. With the black **Cylinder (k)** in hand unscrew the upper part. Remove the **Piston (h)** with mounted **Cup Seal (m)**.

**Models of all sizes:**

- 6) Remove the **Ejector Spring (j)**.
- 7) Set all components of the lower part aside or place them in an autoclave pouch.

### 5.2.2 Reassembly

Before reassembling the pipette, check each component for lint or dust particles. It is recommended to replace the **O-Ring** (black, g) and **Seal** (white, f) or **Cup Seal** (m).

- 1) Lightly lubricate the Piston, O-Rings and Seals (see “5.4.3 Lubrication” on page 22).

#### Models 2 µl–1000 µl:

- 2) Position the **Piston** (h) at the small magnet to connect the Piston to the upper part of the pipette.

#### Models 2 µl–200 µl:

- 3) Slide the **Seal Retainer** (c) onto the Piston and up into the pipette. The end of the Seal Retainer that has an extended edge (lip) faces the upper part of the pipette.
- 4) Slide the **Seal Retainer Spring** (d) onto the Piston. It rests against the Seal Retainer. Slide the **Lower Seal Retainer** (e, 2, 10, 20 µl only) onto the Piston.
- 5) Slide the lightly lubricated **O-Ring** (black, g) and **Seal** (white, f) **Assembly** onto the Piston. The white Seal is closest to the Seal Retainer Spring. Be sure the black O-Ring is securely slid into the white Seal.

**Piston Assemblies** (models 2–200 µl) and **Pistons with Cup Seal** (1000 µl, 5000 µl):

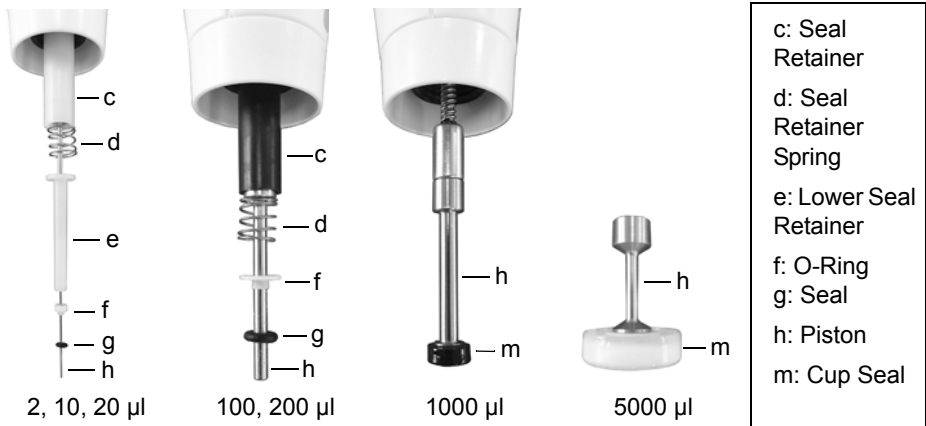

**Models of all sizes:**

6) Slide the **Ejector Spring** (j) onto the top of the black **Cylinder** (k).

**Cylinder Assemblies (a): Models 2 µl– 1000 µl:**

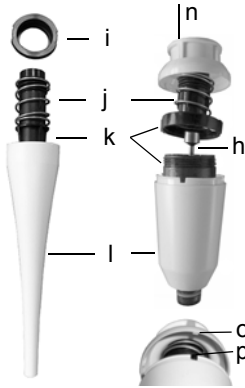

2–1000 µl

5000 µl

- 7) Slide the **Cylinder** (k) into the white **Ejector Sleeve** (l).
- 8) Position the black **Snap Ring** (i) over the **Cylinder** (k) at the top of the **Ejector Sleeve** (l). Turn the sleeve clockwise until the Snap Ring snaps into place and secures the Cylinder in the Cylinder Assembly.
- 9) Slide the **Cylinder Assembly** (a) over the **Piston** (h).

**Model 5000 µl:**

- 7) Push the **Cup Seal** (m) of the **Piston** (h) into the top of **Cylinder**'s lower part (k) and screw on the upper part of **Cylinder** (k).
- 8) Ensure that the four noses (o) of the **Ejector Sleeve Cap** (n) point to the openings (p) of the **Ejector Sleeve** (l) and re-attach the cap.

**Models of all sizes:**

10) Screw clockwise to attach the **Cylinder Assembly** (a) to the body of the pipette.

Perform a leak test (see “5.5.5 Leak test” on page 25) and validate pipetting volumes after reassembly.

### 5.3 Sterilization

If the surface of the EVOLVE Manual Pipettes have been in contact with biohazardous material, they must be decontaminated in accordance to good laboratory practice. Wipe the clean surface with a lint-free cloth, lightly soaked e. g. with the following disinfectants:

- Ethanol 70 %
- Microcide SQ 1:64
- Glutaraldehyde solution 4 %
- Virkon solution 1-3 %

Follow the instructions provided with the disinfectants.

It is not recommended to autoclave the EVOLVE Manual Pipettes. If autoclaving is required, only the lower assembly of the EVOLVE single channel pipettes can be autoclaved.



#### **WARNING**

***Service is required after autoclaving the EVOLVE Manual Pipettes!***

*Do not autoclave the entire unit. Multichannel pipettes can NOT be autoclaved, they might be damaged!*

*As-found calibration (measurement report, indicating “before” data) is not possible after autoclaving!*

#### 5.3.1 Autoclaving the disassembled components

Place the disassembled components (see [5.2.1](#)) into steam autoclave in an autoclave pouch:

##### Single channel 2–1000 µl:



##### Single channel 5000 µl:



You may autoclave the components at 121°C, 1 bar overpressure for 20 minutes.



#### **CAUTION**

***Service is required after autoclaving the EVOLVE Manual Pipettes!***

## 5.4 Servicing

### 5.4.1 Shipping to INTEGRA Biosciences

For any service or repairs, please contact your local service technician.

**WARNING**

*If working with infectious materials, e. g. human pathogens, the EVOLVE Manual Pipettes need to be decontaminated before sending them to service and the declaration on the absence of health hazards must be signed. This is necessary to protect service personnel.*

### 5.4.2 Changing O-rings of tip fittings

200 µl, 1000 µl and 5000 µl EVOLVE Manual Pipettes feature tip fittings with red O-rings. This O-ring is used to seal against the inside wall of GripTips and provides a robust seal.

O-rings are made of durable silicone. If necessary, e.g. in case of a leakage due to damaged O-ring, you can replace these O-rings. A set of spare O-rings can be ordered separately, see [“7.2 Consumables” on page 33](#).

**WARNING**

*Avoid mechanical damage of the tip fittings.*

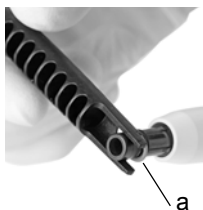

For 200 µl or 1000 µl pipettes, slide the Multipurpose Tool sideways onto the tip fitting until the O-ring (a) builds a loop. Remove the O-ring with plastic tweezers.

For 5000 µl pipettes, simply use plastic tweezers to remove the O-ring.



Slide a new O-ring over the tip fitting (b).

### 5.4.3 Lubrication

The internal seals and O-rings are subject to wear. An undamaged thin lubricant film is important to keep the seals tight. The lubricant recommended depends on the EVOLVE pipette size, see [“7.2 Consumables”](#) on page 33:

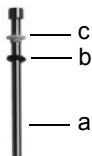

#### Single channel 2 µl– 200 µl models:

Use Fluorocarbon Gel (#100-00136-50) to lightly lubricate the piston (a) without components (c, d) slid onto. Put a drop of grease onto your fingers, lubricate the black O-ring (b) and slide it over the white seal (c).

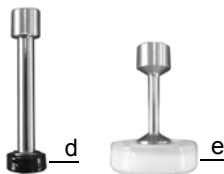

#### Single channel 1000 µl and 5000 µl models:

Use the Super-O-Lube (#100-00135-50) to lightly lubricate the outer ring of the Cup Seals (d, e). Do not lubricate the bottom of Cup Seals.

## 5.5 Calibration

The EVOLVE Manual Pipettes are factory tested and calibrated under environmentally controlled conditions using a gravimetric procedure in accordance with ISO 8655 standards. For the accuracy and precision specifications, see “6.2 Pipette specifications” on page 30.

For information regarding calibration service, please contact your local dealer.

### 5.5.1 Materials

- Precision balance with 0.01 mg readability
- ASTM Class 2 or OIML E2 test weights
- Evaporation trap for balance
- Weighing vessel (optimally the height-to-diameter ratio is at least 3:1)
- Measurement equipment for temperature, humidity and atmospheric pressure
- Distilled water (Grade 3 according to ISO 3696)
- New non-filtered GripTips matching the pipette volume (see section 7.2)
- 1 beaker with distilled water

### 5.5.2 Definitions

**Blow-out:** Discharges any residual liquid from the pipette tip.

**Blow-in:** After the blow-out, the piston moves back into home position. This causes a slight intake of air (or liquid if tips remain in the liquid).

**Two step blow-out:** To avoid an early blow-in, keep the plunger pressed after dispensing, remove the tips from liquid and then release the plunger.

**Pre-wet:** The action of pre-coating the inside of the liquid contacting parts with a thin film of the same liquid. Additionally, it equilibrates humidity of the air space inside tip and the pipette.

**Touch off:** Touching the pipette tip against the surface liquid or side of well-plate to release any sample liquids that might be on the end of the pipette tip.

### 5.5.3 Test conditions and environment

Tests and calibrations should be performed in conditions and environment according to ISO 8655-6 standard.

- Temperature needs to be between 18–25 °C and remain constant ( $\pm 0.5$  °C) throughout the calibration.
- Optimal relative humidity of the environment is >50% and around the dispensing position 80%.
- GripTips, pipettes and distilled water need to be in the calibration laboratory for at least 2 hours prior to calibration to reach temperature equilibrium with the environment.
- The balance must be validated using reference weights before and after a measuring series. A low and high volume weight should be used. E.g.:
  - 100 g (Mettler Toledo, #11119250)
  - 10 g (Mettler Toledo, #11119220)
  - 1 g (Mettler Toledo, #11119190)
  - 10 mg (Mettler Toledo, #11119130)



#### **CAUTION**

*Always use new, pre-wetted GripTips for leak test and calibration.*

### 5.5.4 Pre-wetting of tips

Pre-wet new GripTips three times prior to starting tests and calibrations. This is required every time a tip is changed.

- 1) Set the pipette to aspirate full volume.
- 2) Attach a new unused GripTip which correspond to the volume range of the pipette directly from the rack without touching the tip by hand.
- 3) Use a separate waste container for pre-wet dispenses.
- 4) Push down the Plunger to the first stop. Aspirate by releasing with medium speed.
- 5) Dispense: Keep the Plunger pressed to the first stop until all liquid is expelled.

At the end of the third cycle push the Plunger to the second stop, remove the tip from the liquid and then release the Plunger to perform a two-step blowout.



### 5.5.5 Leak test

It is recommended to perform a leak test every 3 months or when errors occur.

- 1) Prewet tips as described above.
- 2) Set the EVOLVE Manual Pipettes to aspirate full volume.
- 3) Push down the Plunger to the first stop. Aspirate full volume by releasing with medium speed and verify liquid level is not decreasing during 10 seconds while GripTips are still in distilled water.
- 4) Remove the GripTips from the liquid and hold the pipette at a 20° angle. Wait for 20 seconds.
  - a) Observe whether liquid droplets are forming at the end of the GripTips.
  - b) On a multichannel pipette, verify liquid level is even across all channels.
- 5) Immerse GripTips approximately 2 mm into distilled water and push and release the Plunger to mix six times.
  - a) Observe whether air bubbles are forming when dispensing.
  - b) On a multichannel pipette, check whether the levels stay approximately on the same level across all channels.
- 6) At the end push the Plunger to the second stop and remove the tip from the liquid before releasing.

### Signs indicating a leak

- 1) During the mix cycle in the leak test, the liquid level of 1 channel is decreasing.



#### **NOTE**

*A decreasing liquid level at aspiration could be an indication of a slow leak. Performing a retest at 10 mixes may help identify a slow leak.*

- 2) Liquid is left in a tip after the last dispense during the leak test.
- 3) One or more channels show air bubbles during the mix cycle in the leak test.
- 4) Droplets are forming when holding the pipette in the air for 20 seconds, even if a pre-wet was performed.
- 5) The liquid levels are not equal on all channels after aspiration.

If the pipette is leaking, change O-rings (see [5.4.2](#)) and lubricate pistons (see [5.4.3](#)) or contact your service technician.

### 5.5.6 Obtaining the actual volume

INTEGRA certifies the pipettes at 10%, 50% and 100% of the nominal value. For each volume 5 measurements are taken from all channels.

#### General

- 1) Always use new, unused GripTips, also when changing the test volume (e.g. from 200  $\mu$ l to 20  $\mu$ l).
- 2) Always pre-wet (section [5.5.4](#)) when using a new GripTip. For a low volume measurement, first set the maximum volume for the pre-wet and then change to the volume to be measured.
- 3) After dispensing, perform a touch off to make sure no liquid remains on the tip.

#### Gravimetric testing

- 1) Write down the ambient temperature and air pressure.
- 2) Set the pipette to the high test volume.
- 3) Perform a pre-wet, see [5.5.4](#).
- 4) The first and second dispense to the balance should not be recorded. After each dispense re-tare the balance.
- 5) Aspirate the Target volume of water keeping the pipette in a vertical to 20-degree position while immersing the pipet tip 2–3 mm below the surface of the water. When withdrawing the tip from the liquid, gently wipe the tip against the side wall of the vessel to remove any liquid from the outside of the pipet tip.
- 6) Start the first measurement. Always pipet directly into the liquid of the weigh container on the balance. At the end push the Plunger to the second stop and hold the plunger pressed until the pipette is removed again from the weigh vessel to perform a 2-step blowout. Record the weight from the balance.
- 7) After completing the 5 high volume measurements, continue with the mid and low test measurements by repeating steps 3–6.

### 5.5.7 Calculation of accuracy and precision

#### Accuracy

The ability of a pipette to aspirate or dispense the exact volume desired. It indicates the proximity of measurement results to the true value. Accuracy is also known as systematic error and as the name indicates, can be corrected/calibrated.

#### Precision, coefficient of variation (CV)

Precision indicates the repeatability or reproducibility of the measurement. It is also called random error and is therefore an unpredictable error, which can not be corrected/calibrated.

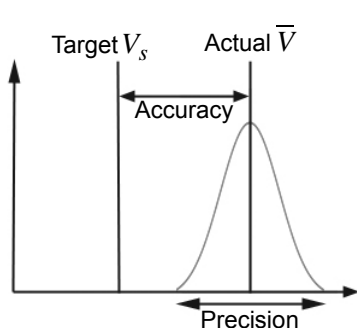

The following symbols are used throughout this text:

$V_s$  = Selected test or target Volume

$m_i$  = Measured Liquid Weight (g)

$Z$  = Z factor, see [6.36.3](#)

$V_i$  = Converted Volume (ml or  $\mu$ l)

$\bar{V}$  = Actual mean Volume (ml or  $\mu$ l)

$n$  = Number of measurements

#### Conversion of the mass to volume

The values obtained by balance readings are in grams. These values need to be converted to micro liters using the Z correction factor. It takes into account the water density and air buoyancy during weighing at the corresponding test temperature. To determine the correct Z factor, find the intersection between temperature and air pressure in [Table 6.36.3](#). Round up temperature and air pressure values.

Multiply each weight  $m_i$  obtained in [5.5.6](#) with the corresponding Z factor:

$$V_i = m_i \times Z$$

Add together the volumes  $V_i$  delivered, divide the sum by  $n$  (e.g.  $n = 5$ ) to calculate the mean volume  $\bar{V}$  (in millilitres or micro litres) delivered at the test temperature, which is the Actual Volume:

$$\bar{V} = \frac{1}{n} \times \sum_{i=1}^n V_i$$

**Calculation of systematic error (accuracy)**

The systematic error  $e_s$  can be calculated using the following equation with  $V_s$  being the selected test volume:

$$e_s = \bar{V} \times V_s$$

or in percent:

$$e_s = \frac{100 \times (\bar{V} \times V_s)}{V_s}$$

**Calculation of random error (precision %)**

To calculate the random error as the repeatability standard deviation  $s_r$ , use the following equation:

$$s_r = \sqrt{\frac{\sum_{i=1}^n (V_i - \bar{V})^2}{n - 1}}$$

The random error can also be expressed as a percentage, by the coefficient of variation  $CV$ , using equation:

$$CV = 100 \times \frac{s_r}{\bar{V}}$$

If the pipette is properly calibrated, the Target volume  $V_s$  should equal the Actual volume  $\bar{V}$  within the accuracy specifications of the pipette.

**5.5.8 Adjusting EVOLVE Manual Pipettes**

Compare the calculated accuracy and precision values with the corresponding pipette specifications given in section [6.2](#).

The industry standard is to test and present specifications using neat transfers. This is aspirating and dispensing the same volume.

In case a EVOLVE Manual Pipette has not met the calibration specifications it needs to be adjusted. This can be corrected with the Multipurpose Tool.

Put the two teeth of the Multipurpose Tool into the slots on the top of the pipette.

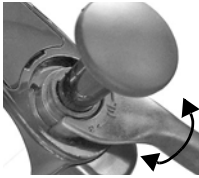

Rotate clockwise to increase the volume (slight turn up to a full turn).

Rotate counterclockwise to decrease the volume (slight turn up to a full turn).



**NOTE**

*Validate the new volume set by repeating the gravimetric testing.*

## 5.6 Equipment disposal



The EVOLVE Manual Pipettes must not be disposed of with unsorted municipal waste.

Dispose of the EVOLVE Manual Pipettes in accordance with the laws and regulations in your area.

## 6 Technical Data

### 6.1 Environmental conditions

#### Operation

Temperature range	5–40°C
Humidity range	Max. rel. humidity 80% for temperatures up to 31°C, decreasing linearly to 50% rel. humidity at 40°C.
Altitude range	<2000 m

### 6.2 Pipette specifications

EVOLVE Manual Pipettes					Manufacturer	
Channel	Part No.	Volume Range (µl)	Volume Increments (µl)	Test Volume (µl)	Accuracy (±%)	Precision (≤%)
1	3011	<b>0.2–2</b>	0.001	0.2	12.0	6.0
				1	3.0	1.6
				2	1.8	1.0
1	3012	<b>1–10</b>	0.01	1	5.0	3.0
				5	1.5	0.8
				10	1.2	0.5
1	3013	<b>2–20</b>	0.01	2	7.0	2.0
				10	1.6	0.5
				20	1.2	0.35
1	3015	<b>10–100</b>	0.1	10	3.5	1.0
				50	1.0	0.35
				100	0.8	0.2
1	3016	<b>20–200</b>	0.1	20	2.5	1.0
				100	1.0	0.3
				200	0.7	0.18
1	3018	<b>100–1000</b>	1	100	3.0	0.6
				500	1.0	0.3
				1000	0.8	0.2
1	3019	<b>500–5000</b>	5	500	3.0	0.7
				2500	1.2	0.3
				5000	0.6	0.18

Precision = Coefficient of Variation.

EVOLVE Manual Pipettes					Manufacturer	
Channel	Part No.	Volume Range (µl)	Volume Increments (µl)	Test Volume (µl)	Accuracy (±%)	Precision (≤%)
8	3022	1–10	0.01	1	12.0	7.0
				5	4.0	3.0
				10	2.0	1.2
8	3024	5–50	0.05	5	5.0	2.0
				25	2.0	1.0
				50	1.2	0.5
8	3025	10–100	0.1	10	5.0	2.0
				50	2.0	0.8
				100	1.2	0.5
8	3026	20–200	0.1	20	5.0	1.3
				100	2.0	0.5
				200	1.2	0.4
12	3032	1–10	0.01	1	12.0	7.0
				5	4.0	3.0
				10	2.0	1.2
12	3034	5–50	0.05	5	5.0	2.0
				25	2.0	1.0
				50	1.2	0.5
12	3035	10–100	0.1	10	5.0	2.0
				50	2.0	0.8
				100	1.2	0.5
12	3036	20–200	0.1	20	5.0	1.3
				100	2.0	0.5
				200	1.2	0.4

The multichannel pipettes' specifications represent the performance of all channels of the pipettes.

Precision = Coefficient of Variation.

### 6.3 Z Correction Factors

Temp. (°C)	Air Pressure (kPa)						
	80	85	90	95	100	101.3	105
18.0	1.0022	1.0023	1.0023	1.0024	1.0025	1.0025	1.0025
18.5	1.0023	1.0024	1.0024	1.0025	1.0025	1.0026	1.0026
19.0	1.0024	1.0025	1.0025	1.0026	1.0026	1.0027	1.0027
19.5	1.0025	1.0026	1.0026	1.0027	1.0027	1.0028	1.0028
20.0	1.0026	1.0027	1.0027	1.0028	1.0028	1.0029	1.0029
20.5	1.0027	1.0028	1.0028	1.0029	1.0029	1.0030	1.0030
21.0	1.0028	1.0029	1.0029	1.0030	1.0031	1.0031	1.0031
21.5	1.0030	1.0030	1.0031	1.0031	1.0032	1.0032	1.0032
22.0	1.0031	1.0031	1.0032	1.0032	1.0033	1.0033	1.0033
22.5	1.0032	1.0032	1.0033	1.0033	1.0034	1.0034	1.0034
23.0	1.0033	1.0033	1.0034	1.0034	1.0035	1.0035	1.0036
23.5	1.0034	1.0035	1.0035	1.0036	1.0036	1.0036	1.0037
24.0	1.0035	1.0036	1.0036	1.0037	1.0037	1.0038	1.0038
24.5	1.0037	1.0037	1.0038	1.0038	1.0039	1.0039	1.0039

Z values in microliters per milligram



## 7 Accessories and Consumables

### 7.1 Accessories

General	Part No.
EVOLVE Pipette Multipurpose Tool (for calibration, o-ring removal and plunger spring exchange)	3200
EVOLVE Pipette Shelf Hook, 1/pack	3210
EVOLVE Pipette Shelf Hook, 5/pack	3211
Linear Stand for manual/electronic pipettes	3215

Replacement Plunger Caps (5/pack)	Part No.
Black for use with any pipette	3220
Purple for use with 2 µl, 10 µl, 20 µl manual pipettes	3221
Yellow for use with 50 µl, 100 µl manual pipettes	3222
Green for use with 200 µl manual pipettes	3223
Blue for use with 1000 µl manual pipettes	3224
Orange for use with 5000 µl manual pipettes	3225

EVOLVE Control Spring Assembly	Part No.
for single channel pipettes 2, 10, 20, 100, and 200 µl only	3230

### 7.2 Consumables

O-rings for tip fittings	Part No.
200 µl, Replacement kit 24/pack (300 µl)	100-00027-50
1000 µl, Replacement kit 24/pack (1250 µl)	100-00028-50
5000 µl Replacement kit 10/pack	100-00029-00

Lubricant for pipettes and O-rings	Part No.
Lube Parker Super-O-Lube, Silicone based, 50 g / 2 oz, for single channel 1250 µl and 5000 µl pipettes	100-00135-50
Grease Grease Nye Fluorocarbon Gel 807, 5 g / 0.2 oz, for single channel 12.5 µl, 125 µl and 300 µl pipettes	100-00136-50

<b>GripTips for all INTEGRA Manual and Electronic Pipettes</b>		<b>Part No.</b>
<b>Purple</b>	Bulk pack, 1 bag of 1000 tips, non-sterile, LONG	4401
<b>LONG:</b>	5 inserts of 384 tips, non-sterile, LONG, GREEN CHOICE	4402
2 µl,	5 racks of 384 tips, non-sterile, LONG	4403
10 µl,	5 racks of 384 tips, sterile, LONG	4404
(12.5 µl),	5 racks of 384 tips, sterile, filter, LONG	4405
20 µl	5 inserts of 384 tips, pre-sterilized, LONG, GREEN CHOICE	4406
<b>Purple:</b>	Bulk pack, 1 bag of 1000 tips, non-sterile	4411
2 µl,	5 inserts of 384 tips, non-sterile, GREEN CHOICE	4412
10 µl,	5 racks of 384 tips, non-sterile	4413
(12.5 µl),	5 racks of 384 tips, sterile	4414
20 µl	5 racks of 384 tips, sterile, filter	4415
	5 inserts of 384 tips, pre-sterilized, GREEN CHOICE	4416
<b>Yellow:</b>	Bulk pack, 1 bag of 1000 tips, non-sterile	4421
50 µl,	5 inserts of 384 tips, non-sterile, GREEN CHOICE	4422
100 µl,	5 racks of 384 tips, non-sterile	4423
(125 µl)	5 racks of 384 tips, sterile	4424
	5 racks of 384 tips, sterile, filter	4425
	5 inserts of 384 tips, pre-sterilized, GREEN CHOICE	4426
<b>Green:</b>	Bulk pack, 1 bag of 1000 tips, non-sterile	4431
200 µl,	5 inserts of 96 tips, non-sterile, GREEN CHOICE	4432
(300 µl)	5 racks of 96 tips, non-sterile	4433
	5 racks of 96 tips, sterile	4434
	5 racks of 96 tips, sterile, filter	4435
	5 inserts of 96 tips, pre-sterilized, GREEN CHOICE	4436
<b>Blue:</b>	Bulk pack, 1 bag of 500 tips, non-sterile	4441
1000 µl,	5 inserts of 96 tips, non-sterile, GREEN CHOICE	4442
(1250 µl)	5 racks of 96 Tips, non-sterile	4443
	5 racks of 96 Tips, sterile	4444
	5 racks of 96 Tips, sterile, filter	4445
	5 inserts of 96 tips, pre-sterilized, GREEN CHOICE	4446

<b>GripTips for all INTEGRA Manual and Electronic Pipettes</b>		<b>Part No.</b>
<b>Orange:</b>	Bulk pack, 1 bag of 250 tips, non-sterile	4451
5 ml	5 racks of 48 Tips, non-sterile	4453
	5 racks of 48 Tips, sterile	4454
	5 racks of 48 Tips, sterile, filter	4455
	Individually wrapped, 100 tips per case, sterile	4456

---

## Imprint

© 2016 INTEGRA Biosciences AG

All rights to this documentation are reserved. In particular the rights of reproduction, processing, translation and the form of presentation lie with INTEGRA Biosciences AG. Neither the complete documentation nor parts thereof may be reproduced in any way, or stored and processed using electronic media or distributed in any other way without the written consent of INTEGRA Biosciences AG.

This operating instruction manual has part number 900-00010-00, the version is V01. EVOLVE and GripTip are trademarks of INTEGRA Holding, Switzerland.

### Manufacturer

#### **INTEGRA Biosciences AG**

CH-7205 Zizers, Switzerland

T +41 81 286 95 30

F +41 81 286 95 33

[info@integra-biosciences.com](mailto:info@integra-biosciences.com)

[www.integra-biosciences.com](http://www.integra-biosciences.com)

#### **INTEGRA Biosciences Corp.**

Hudson, NH 03051, USA

T +1 603 578 5800

F +1 603 577 5529

### Customer service

Please contact your local INTEGRA Biosciences representative.

To find out name and address of your local representative go to

[www.integra-biosciences.com](http://www.integra-biosciences.com).

Further information and operating instructions in other languages are available on [www.integra-biosciences.com](http://www.integra-biosciences.com) or on request [info@integra-biosciences.com](mailto:info@integra-biosciences.com).