



# Getinge Lancer Ultima labware washing systems

Freestanding series



# Professional cleaning results

– integrated systems,  
repeatable results

From quality control to general laboratory research, Getinge Lancer Ultima series washers meet space and budget requirements in laboratories performing a range of critical applications where clean labware is essential.

Typical applications include analytical chemistry, quality control, pharmaceutical and environmental science laboratories, wastewater treatment, food and beverage analysis, public health and consumer product testing facilities.

The exclusive Prolux programmable microprocessor controller commands a full range of prewash, wash, rinse and drying functions through simple touchscreen menus on all Ultima series washers. The convenience of five preset programs for light to heavy loads simplifies operation, while more complex programs can be customized whenever needed to meet specific applications.



Getinge Lancer Ultima model 1300 LX freestanding labware washer, shown with accessory loading rack, sold separately.



**Quiet Operation**  
Noise reduction design minimizes sound for quiet operation.



**Cool Surface**  
High-performance insulation contains heat and limits energy consumption.



Prolux programmable microprocessor controller with intuitive touchscreen user interface.

Control screen shows actual cycle performance, alarm events. Data is captured for documentation and communication.

Preset or user programmed cycles are fully adjustable to permit multiple combinations of prewash, wash, rinse, acid rinse, purified final rinse, HEPA filtered forced air drying, controlled duration, temperature and more.

High efficiency powerful fluid circulation with direct fluid path and rear manifold connections deliver optimal pressure and flow rates.

Chamber walls made in durable AISI 316L stainless steel material.

Injector jet performance provides inside out wash and rinse functions.

Stainless steel top and bottom spray arms and multiple levels of injection washing ensure thorough spray coverage.

Two integrated automatic chemical dosing pumps are standard on all models. Convenient on-board chemical storage beneath chamber saves space.



**View-In-Process Window**

An optional View-In-Process (VIP) window includes an interior LED light for visual verification of the interior load during the cycle.

Getinge Lancer Ultima model 1400 LXP freestanding labware washer, shown with accessory loading rack, sold separately.

# Meeting a variety of laboratory needs

The Getinge Lancer Ultima series freestanding washers include six high-performance models that offer a range of labware loading options using baskets, injector racks or combination racks for the best high capacity processing of multiple labware types in the industry.



910 LX / 1300 LX / 1400 LX features	1400 LXP / 1600 LXP features	1800 LXA features
Prolux control interface	Prolux Plus control interface	Prolux Plus control interface
Manual fold down door	Manual fold down door	High impact glass, vertical sliding doors
Forced-air drying, injectors, HEPA filtered	Forced-air drying, injectors, HEPA filtered	Forced-air drying, injectors, HEPA filtered

Capacity comparison					
Model	Volume	Interior (W x H x D)	Positions	Wash levels	Configurations
910 LX	160 L (5.7 cu. ft.)	535 x 544 x 520 mm (21.1" x 21.4" x 20.5")	3	2	3
1300 LX	180 L (6.4 cu. ft.)	535 x 644 x 520 mm (21.1" x 25.4" x 20.5")	4	3	5
1400 LX / 1400 LXP	304 L (10.7 cu. ft.)	626 x 773 x 629 mm (24.6" x 30.4" x 24.8")	4	3	6
1600 LXP	408 L (14.4 cu. ft.)	703 x 858 x 678 mm (27.7" x 33.8" x 26.7")	5	4	12
w/optional height extension	528 L (18.6 cu. ft.)	703 x 1108 x 678 mm (27.7" x 43.6" x 26.7")			
1800 LXA	458 L (16.2 cu. ft.)	1100 x 793 x 526 mm (43.3" x 31.2" x 20.7")	4 x 2	3 x 2	20*

\* Three racks each side; six configurations each side.

Models shown (left to right) 910 LX, 1300 LX, 1400 LX, 1400 LXP, 1600 LXP with optional VIP window; 1800 LXA, glass door standard.

# Small spaces, impressive capacity

## 910 LX

Drawings display front and side of unit, with door swing allowance.

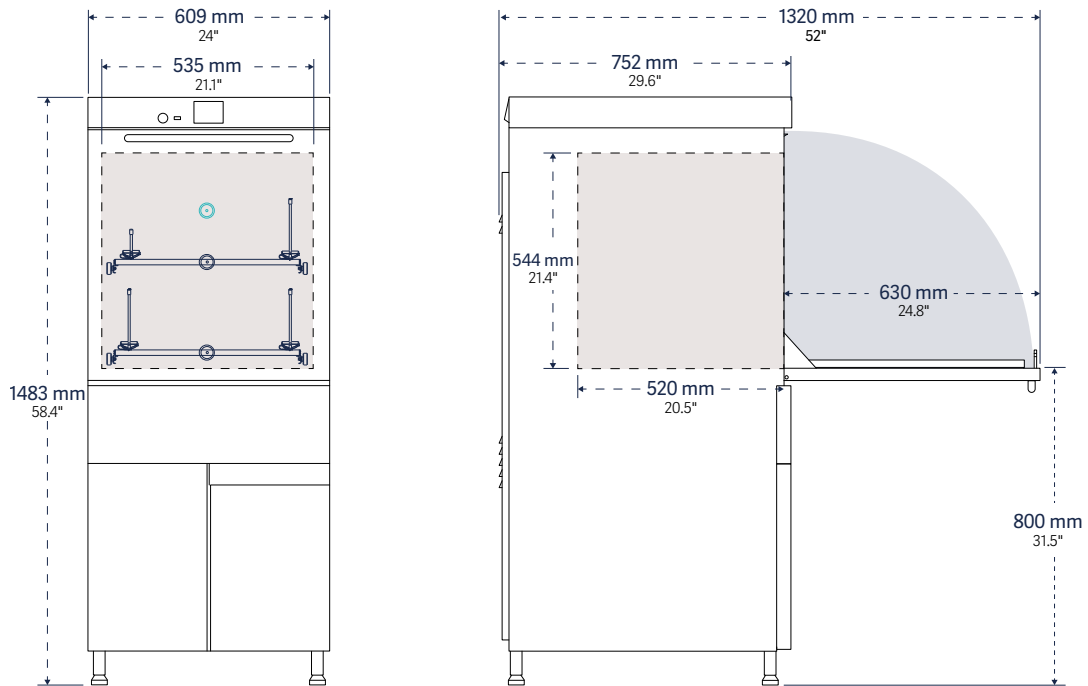

Model	Interior dimensions	Exterior dimensions	Water per fill*	Programs	
	W x H x D	W x H x D		presets	custom
910 LX	535 x 544 x 520 mm 21.1" x 21.4" x 20.5"	609 x 1483 x 752 mm 24" x 58.4" x 29.6"	13 (3.4)	5	35

\* Total water consumption per fill based on reservoir sump and all fluid path fill volumes, care should be taken when evaluating comparative water consumption claims.

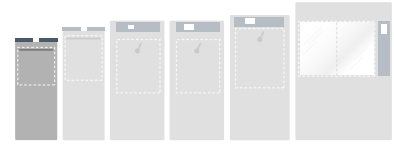

**910 LX**  
3.5" Prolux Control Interface,  
Standard Monitoring.



Stainless steel top and bottom spray arms on all models ensure complete washing and rinsing of glassware exterior and interior of large mouthed glassware.



**910 LX**

Wash load configurations

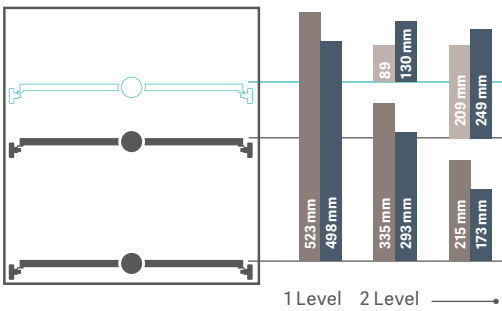

Sound Level  
<60 dB(A)

- PST Basic basket
- IXC / IXL injection racks (long / short jets)
- PSBT Basic basket with spray arm

Model	Cycle function			Drying	Chemical dosing				Net weight Empty kg (lb)
	Wash temp. max. °C (°F)	Rinse purified water	Rinse acid		Automatic pumps	On-Board chemical storage	Level sensors	Water softener	
<b>910 LX</b>	95°C (203°F)	<span style="display: inline-block; width: 15px; height: 15px; background-color: #191970;"></span>	<span style="display: inline-block; width: 15px; height: 15px; background-color: #191970;"></span>	Forced-air chamber and injectors; HEPA filtered	2 (max 3)	<span style="display: inline-block; width: 15px; height: 15px; background-color: #191970;"></span>	2 (max 3)	<span style="display: inline-block; width: 15px; height: 15px; border: 1px solid black;"></span>	143 (315)

/  Standard / optional features

# Compact footprint, lasting impression

## 1300 LX

Drawings display front and side of unit, with door swing allowance.

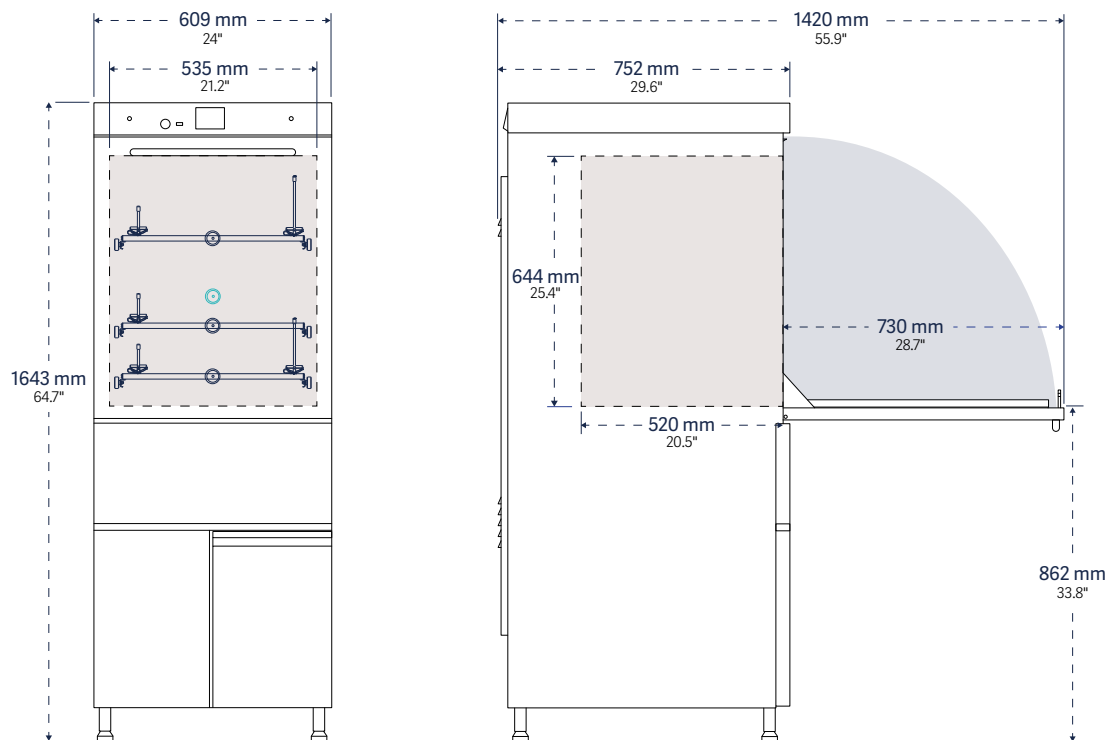

Model	Interior dimensions	Exterior dimensions	Water per fill*	Programs	
	W x H x D	W x H x D		presets	custom
1300 LX	535 x 644 x 520 mm 21.1" x 25.4" x 20.5"	609 x 1643 x 752 mm 24" x 64.7" x 29.6"	15 (4)	5	35

\* Total water consumption per fill based on reservoir sump and all fluid path fill volumes, care should be taken when evaluating comparative water consumption claims.



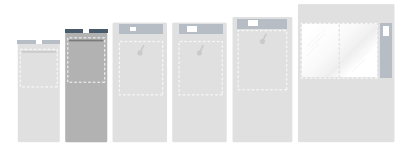

**3.5"** **1300 LX**  
3.5" Prolux Control Interface,  
Standard Monitoring.



For maximum connectivity, all Ultima series washers include a USB port, conveniently located on the front panel for easy access and transfer of cleaning process documentation, including cycle parameters, cycle number, date and time, phase duration, temperature for each phase, and detergent and acid intake.



**1300 LX**  
Wash load configurations

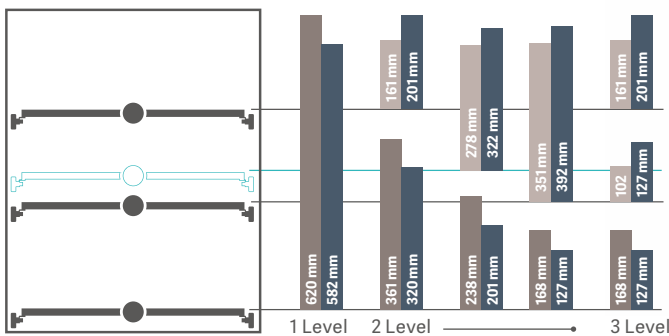

■ PST Basic basket      ■ IXC / IXL injection racks (long / short jets)  
■ PSBT Basic basket with spray arm



Sound Level  
<60 dB(A)

Model	Cycle function				Chemical dosing				Net weight Empty kg (lb)
	Wash temp. max. °C (°F)	Rinse purified water	Rinse acid	Drying	Automatic pumps	On-board chemical storage	Level sensors	Water softener	
<b>1300 LX</b>	95°C (203°F)	■	■	Forced-air chamber and injectors; HEPA filtered	2 (max 3)	■	2 (max 3)	□	145 (319)

■ / □ Standard / optional features

# Space efficiency, multi-level loading

## 1400 LX / 1400 LXP

Drawings display front and side of unit, with door swing allowance.

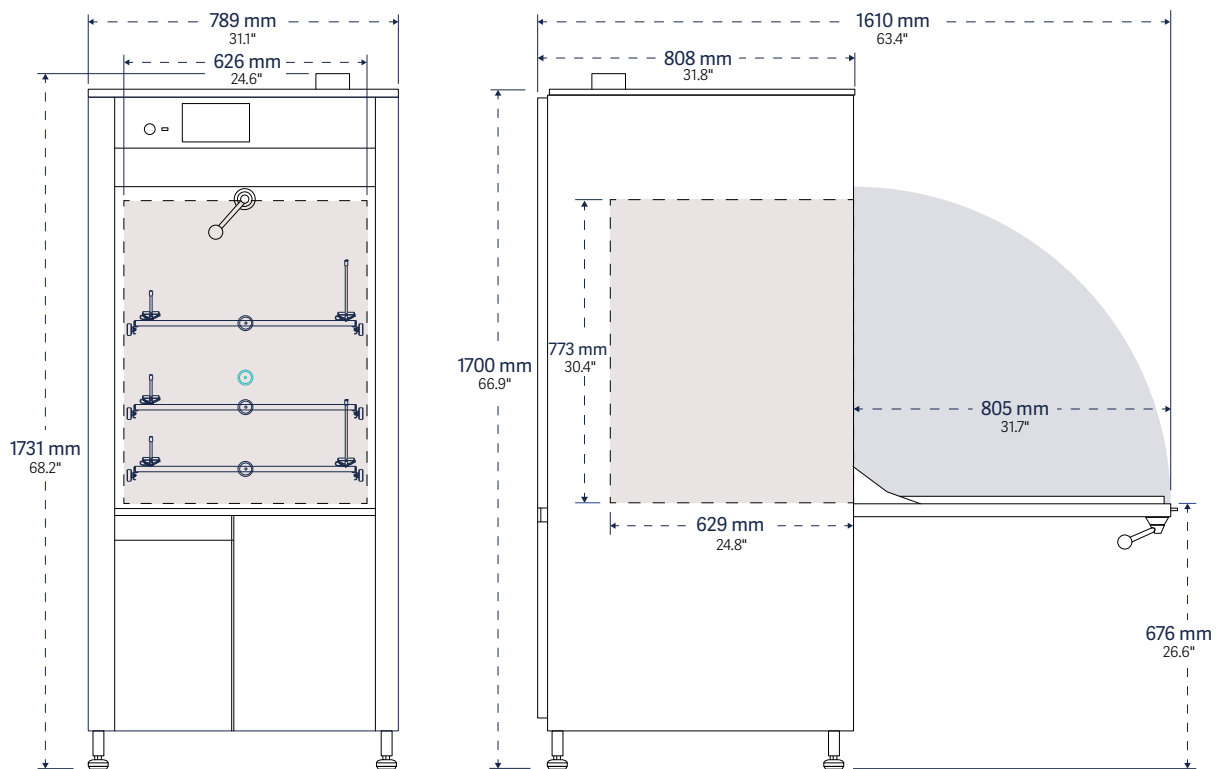

Model	Interior dimensions	Exterior dimensions	Water per fill*	Programs	
	W x H x D	W x H x D		presets	custom
<b>1400 LX</b>	626 x 773 x 629 mm	789 x 1731 x 808 mm	20-25	5	35
<b>1400 LXP</b>	24.6" x 30.4" x 24.8"	31.1" x 68.2" x 31.8"	(5.2-6.6)		

\* Total water consumption per fill based on reservoir sump and all fluid path fill volumes, care should be taken when evaluating comparative water consumption claims.

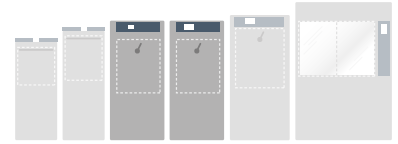

**3.5"** **1400 LX**  
3.5" Prolux Control Interface,  
Standard Monitoring.

**7"** **1400 LXP**  
7" Prolux Plus Control Interface,  
Enhanced Monitoring.

All Ultima series labware washers feature telescopic runners with advanced design for smooth and easy function as well as innovative rack stops for safety and ergonomics.



**1400 LX / 1400 LXP**  
Wash load configurations

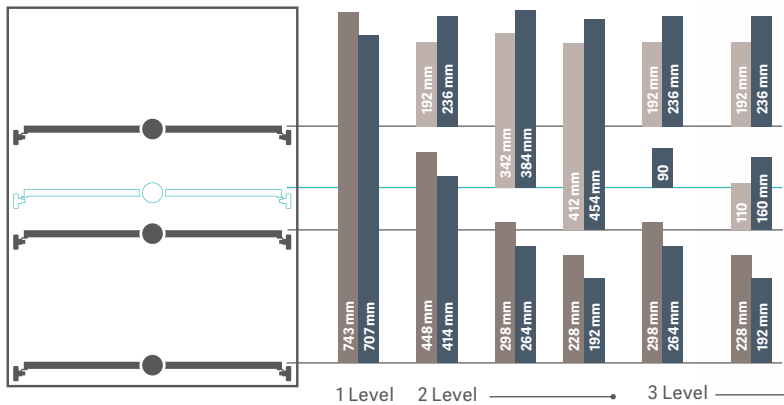

■ PST Basic basket      ■ IXC / IXL injection racks (long / short jets)  
■ PSBT Basic basket with spray arm



Sound Level  
<60 dB(A)

Model	Cycle function				Chemical dosing				Net weight Empty kg (lb)
	Wash temp. max. °C (°F)	Rinse (purified water)	Rinse (acid)	Drying	Automatic pumps	On-board chemical storage	Level sensors	Water softener	
<b>1400 LX</b> <b>1400 LXP</b>	95°C (203°F)	■	■	Forced-air chamber and injectors; HEPA filtered	2 (max 3) 2 (max 4)	■	2 (max 3) 2 (max 4)	□	213 (469)

■ / □ Standard / optional features

# Maximum flexibility

## 1600 LXP

Drawings display front and side of unit, with door swing allowance.

\* Drawing does not include optional chamber height extension.

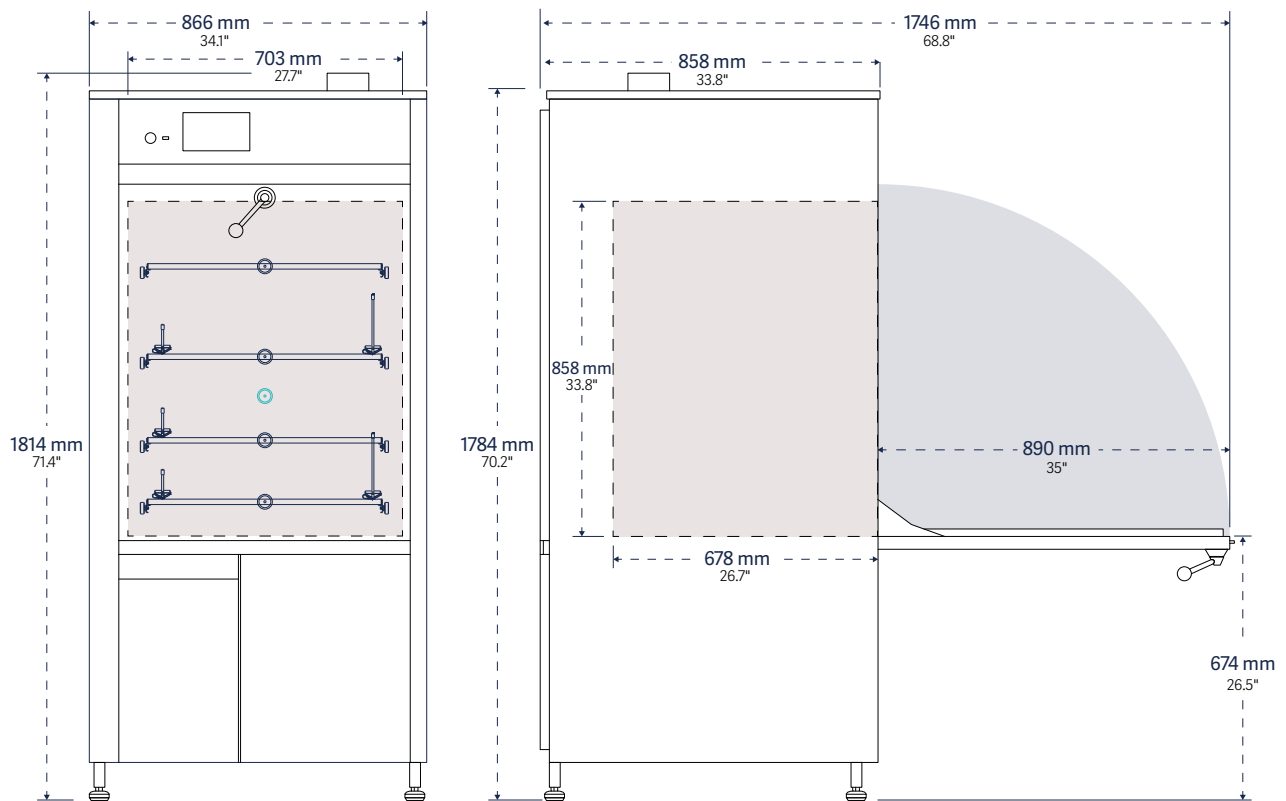

Model	Interior dimensions W x H x D	Exterior dimensions W x H x D	Water per fill* L (gal)	Programs	
				presets	custom
1600 LXP	703 x 858 x 678 mm 27.7" x 33.8" x 26.7"	866 x 1814 x 858 mm 34.1" x 71.4" x 33.8"	30-35 (7.9-9.2)	5	35
w/ optional height extension	703 x 1108 x 678 mm 27.7" x 43.6" x 26.7"	866 x 2064 x 858 mm 34.1" x 81.3" x 33.8"	30-35 (7.9-9.2)	5	35

\* Total water consumption per fill based on reservoir sump and all fluid path fill volumes, care should be taken when evaluating comparative water consumption claims.

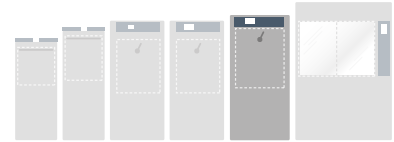

**1600 LXP**  
7" Prolux Plus Control Interface,  
Enhanced Monitoring.



250 mm (9.8")

Model 1600 LXP with optional height extension increases chamber, door and unit height by 250 mm (9.8").



### 1600 LXP

Wash load configurations. Measurements valid for units without the optional height extension.

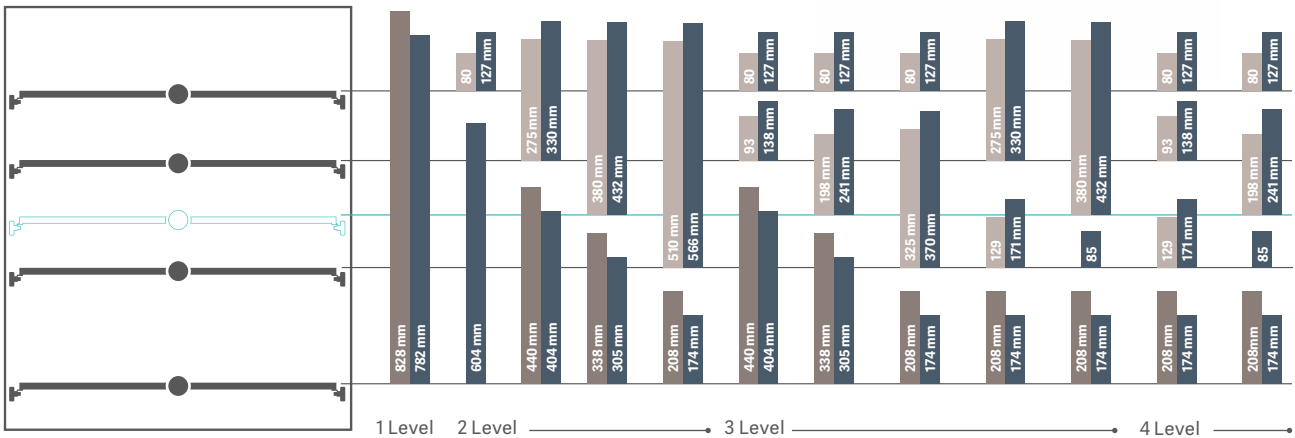

■ PST Basic basket  
■ PSBT Basic basket with spray arm

■ IXC / IXL injection racks (long / short jets)

Sound Level  
<60 dB(A)



Model	Cycle function				Chemical dosing				Net weight Empty kg (lb)
	Wash temp. max. °C (°F)	Rinse purified water	Rinse acid	Drying	Automatic pumps	On-board chemical storage	Level sensors	Water softener	
<b>1600 LXP</b>	95°C (203°F)	■	■	Forced-air chamber and injectors; HEPA filtered	2 (max 4)	■	2 (max 4)	□	215 (474)
<b>w/ optional height extension</b>	95°C (203°F)	■	■	Forced-air chamber and injectors; HEPA filtered	2 (max 4)	■	2 (max 4)	□	240 (529)

■ / □ Standard / optional features

# Vanishing door, easy to load

## 1800 LXA

Drawings display front and side of unit.  
 \* Drawing does not include optional steam condenser.

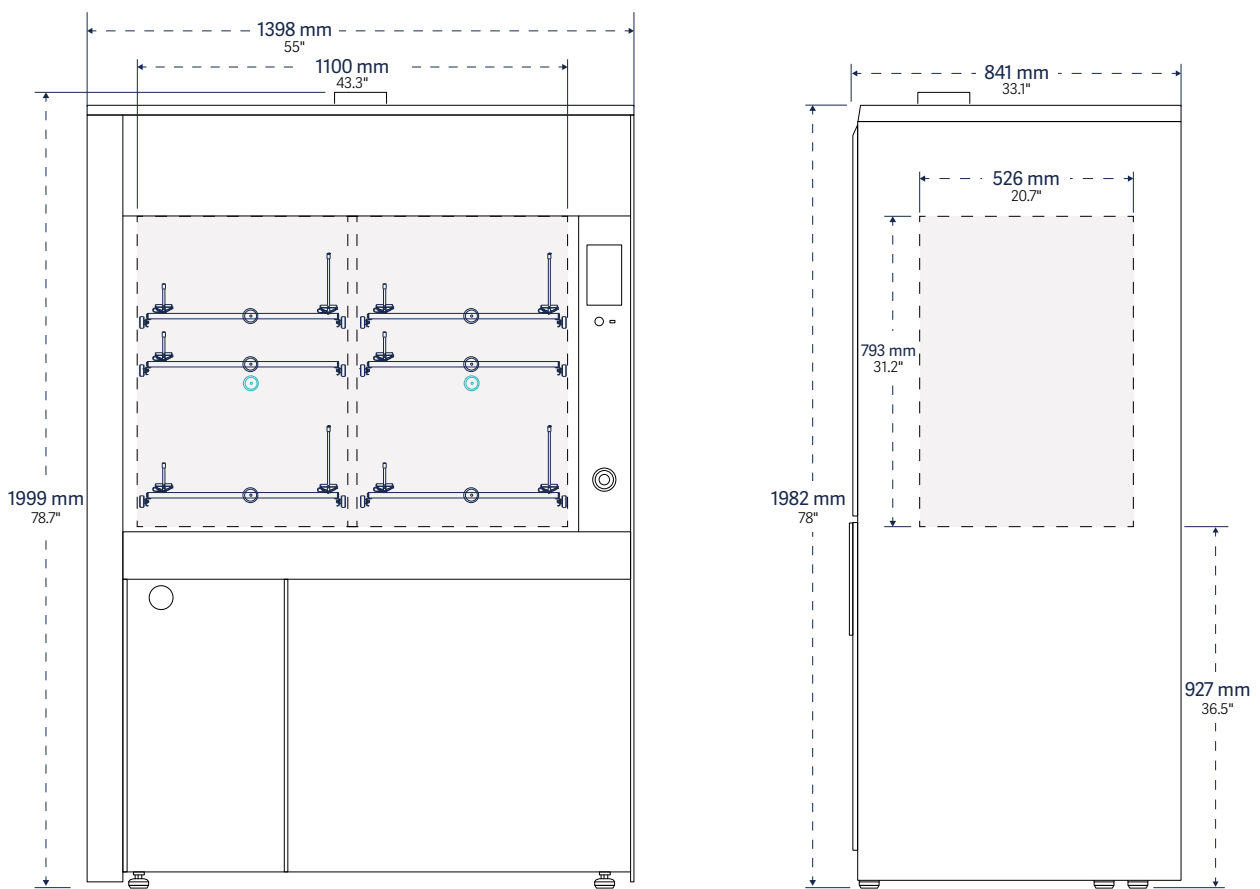

Model	Interior dimensions W x H x D	Exterior dimensions W x H x D	Water per fill* L (gal)	Programs	
				presets	custom
<b>1800 LXA</b>	1100 x 793 x 526 mm 43.3" x 31.2" x 20.7"	1398 x 1999 x 841 mm 55" x 78.7" x 33.1"	40 (10.5)	5	35
<b>w/ optional condenser</b>	1100 x 793 x 526 mm 43.3" x 31.2" x 20.7"	1398 x 2315 x 891 mm 55" x 91.1" x 33.1"	40 (10.5)	5	35

\* Total water consumption per fill based on reservoir sump and all fluid path fill volumes, care should be taken when evaluating comparative water consumption claims.

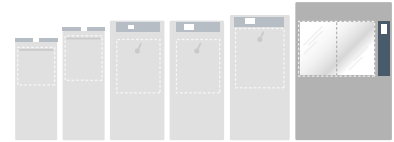

**1800 LX**  
7" Prolux Plus Control Interface,  
Enhanced Monitoring.

The dual pane glass door opens easily by sliding vertically into the cabinet beneath the loading chamber. This design eliminates the need for additional floor space in front or head space above the washer.



**1800 LX**

Wash load configurations per side. Three racks each side; six configurations each rack.

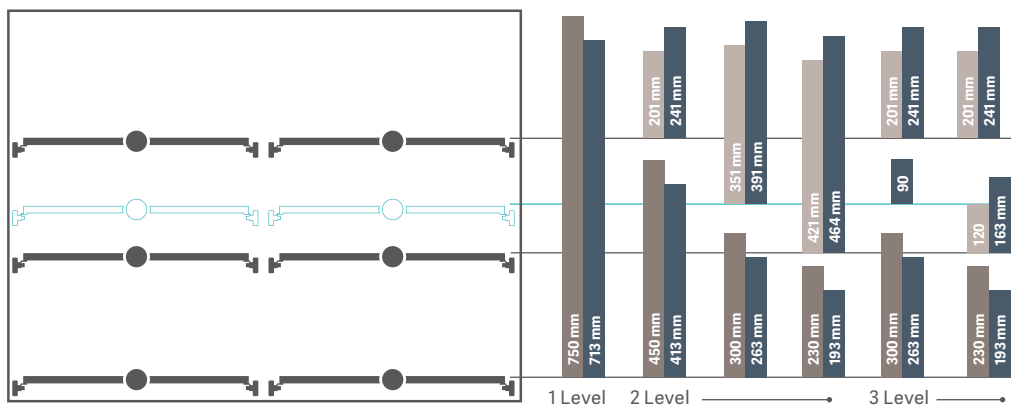

- PST Basic basket
- IXC / IXL injection racks (long / short jets)
- PSBT Basic basket with spray arm



Sound Level  
<65 dB(A)

Model	Cycle function				Chemical dosing				Net weight Empty kg (lb)
	Wash temp. max. °C (°F)	Rinse purified water	Rinse acid	Drying	Automatic pumps	On-board chemical storage	Level sensors	Water softener	
<b>1800 LX</b>	95°C (203°F)	■	■	Forced-air chamber and injectors; HEPA filtered	2 (max 4)	■	2 (max 4)	□	365 (805)
<b>w/ optional height extension</b>	95°C (203°F)	■	■	Forced-air chamber and injectors; HEPA filtered	2 (max 4)	■	2 (max 4)	□	415 (915)

■ / □ Standard / optional features

# Repeatable results

– with reliability, safety and high throughput

## Ergonomic loading configurations.

Unlike oversized washers with less efficient loading patterns, Getinge Lancer Ultima series freestanding labware washers are designed for high-density loading and the most effective use of available interior space. This efficiency maximizes throughput and reduces capital investments, operating costs and the amount of dedicated lab space needed.

- Telescoping load-bearing rails permit extension of racks for easy loading with or without an optional trolley.
- All racks are interchangeable between wash levels thereby minimizing the need for additional accessories.
- Racks for Getinge Lancer Ultima series undercounter models and freestanding models 910 LX, 1300 LX and 1800 LXA are interchangeable.
- The fold-down door creates a platform for proper rack positioning and more comfortable loading and unloading.

## Cleaning performance and safety.

Operating systems are designed for performance, efficiency and high throughput.

- An automatic door lock prevents door opening during active cycles and protects the user from heat and chemical exposure.
- Top and bottom stainless steel spray arms are pressurized to provide exterior coverage to the labware.
- Injector rack manifold connections are located at the rear for proper alignment and the most efficient pressure and flow.
- Washing temperature can be set to a maximum of 95°C (203°F) if required for more difficult soils.
- Automatic Peristaltic pumps are self-contained for accurate and repeatable dosing of detergents or acids required by each cycle.
- Multiple DI rinses can be programmed to eliminate interior and exterior spotting.



The front-loading door folds down to create an ergonomically stable platform for proper rack positioning and easier loading, eliminating the need for a trolley to load or unload glassware. (Does not apply to model 1800 LXA with vertical sliding door).



### Alarms and monitoring

- The high resolution touchscreen color display is easy to read from a distance.
- The intuitive graphic user interface creates a series of visual performance indicators such as active program, time remaining, warning, alarm and cycle completed functions.
- Five preset programs permit one touch operation. Additional cycles are programmed from the graphic user interface.
- An integrated USB port allows easy front panel access for process tracking and data logging. Optional process record printouts available through USB or Ethernet ports are managed by the Prolux controller.

### Construction

The sump, spray arms, interior chamber walls and door are fabricated from 316L stainless steel to resist aggressive chemicals and residues.

- Exterior 304L stainless steel panels resist corrosion, simplify cleaning and protect electrical and plumbing components.
- Double-wall insulated assembly confines heat loss and minimizes noise.
- Easy access stainless steel chamber filters extend washer life by protecting pumps and interior plumbing from debris.
- A compact liquid sump and direct fluid path minimizes water volume per fill, lowers overall consumption per cycle and improves sustainability throughout the useful life.

### Hydraulic design

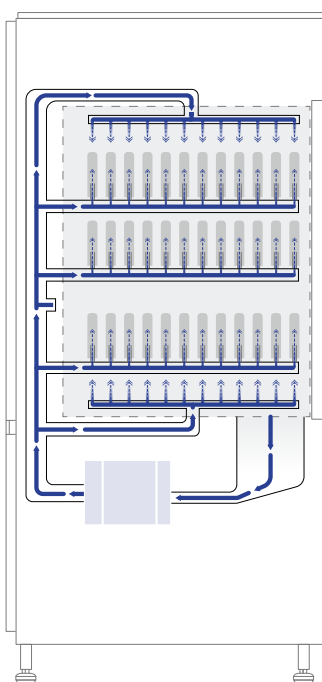

The Getinge Lancer Ultima hydraulic design optimizes pressure and flow for efficient performance at all wash levels.

The combination of a high-performance recirculation pump, straight-line fluid path and center-mounted rack interface assures maximum water flow through spray arms and injectors.

Washer pump is protected from debris by a stainless steel sump screen. The screen lifts out without tools for easy cleaning.

Model 1400 LXP, waterflow.

### View-In-Process



An optional dual pane View-In-Process (VIP) window includes an interior LED light for visual verification of the interior load during the cycle. The light is activated by the On/Off switch through the Prolux controller. Tempered safety glass provides excellent sound and heat abatement and enhances operator safety. Factory installed, specify when ordering.

#### Model 910 LX:

348 mm (13.7") H x 173 mm (6.8") W

#### Models 1300 LX / 1400 LX

#### 1400 LXP / 1600 LXP:

508 mm (20") H x 173 mm (6.8") W

# Simple, flexible, documented, trusted.

## Prolux controller.

The all new 3.5" Prolux and 7" Prolux Plus controllers are based on a high-performance PLC microprocessor designed for simplicity, one-touch start, real-time status indicators and intuitive programming options that permit customization over the range of washer operations.

Both the Prolux and Prolux Plus controller integrate a suite of menu screens that support digital functions from cycle selection, process monitoring, warning advisories, audible and visual alarms, system communications and data capture.

## Operation

- Screen menus and graphic user interfaces are designed to simplify setup and operations including active programs, remaining time, warnings, alarms and cycle complete notifications.
- Five preset programs are factory loaded for one-touch control of most routine applications.
- When additional cycle programs are desired, parameters can be changed through secure access to the administration screen where an intuitive graphic user interface displays all options.

## Communication and connectivity

- A front-panel USB port simplifies direct connection to peripheral devices for cycle tracking and data capture. The port is covered by a protective hood.
- A real-time process record is printed if optional printer is installed.
- Multiple data ports include Ethernet and RS422 connectors.
- Optional printer documents cycle performance, warnings and alarms.



The Prolux and Prolux Plus (above) controllers include a touch-screen interface with a common icon directory that permits scrolling access to primary screens from the same menu. A set of sub-menu screens display additional icon directories specific to the screen functions.

## 910 LX / 1300 LX / 1400 LX



- 3.5" Prolux color touchscreen interface
- 320 x 240 pixel resolution display
- Five presets
- Additional custom program options

## 1400 LXP / 1600 LXP / 1800 LXA



- 7" Prolux Plus color touchscreen interface
- 800 x 480 pixel resolution display
- Five presets
- Additional custom program options



The Prolux control interface features an intuitive menu of primary and secondary screens, configured with icons, to simplify access to all functions. The touchscreen is easily managed with a gloved hand.

### Programming

Programmable cycle parameter selections include:

- **Prewash.** Up to 3 prewashes, 0 to 30 minutes each, temperatures up to 95°C (203°F), chemical dosing as desired.
- **Wash.** 0 to 30 minutes, temperatures up to 95°C (203°F), chemical dosing as desired.
- **Acid rinse.** 0 to 30 minutes, chemical dosing, temperatures up to 95°C (203°F).
- **Running water rinses.** One or more short rinse sequences after the wash or rinse cycle purge the hydraulic circuit of residual detergent and rinsing agents.
- **Rinse, DI.** Up to 4 rinses, 0 to 30 minutes each. Ambient to 95°C (203°F).
- **Final rinse, DI.** 0 to 30 minutes, temperatures up to 95°C (203°F).
- **Drying.** Up to 90 minutes, adjustable. Temperature, ambient to 110°C (230°F), Prolux Plus models; ambient to 85°C (185°F), Prolux models.
- **Cooling.** 0 to 30 minutes, adjustable.

## Display screens

Featured display screens are 3.5" screen. Displays for 7" screens are identical.

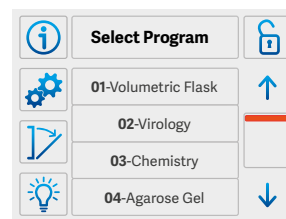

### Program Selection.

The Program Selection screen lists the five factory presets, as well as additional presets added through administrator access.

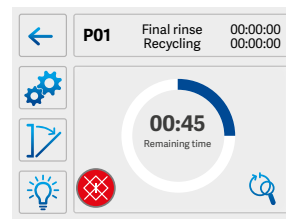

### Cycle in Process.

A real-time status screen displays time remaining until cycle completion and links to cycle detail screens with the touch of a button.

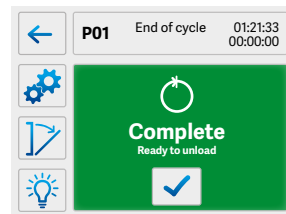

### Cycle Completed.

The green Cycle Completed screen confirms completion of the cycle and indicates the washer is safe to unload.

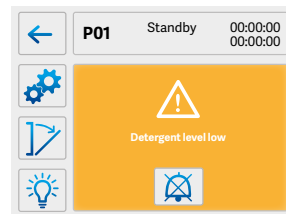

### Warning Message.

The amber Warning Message screen provides a status report to prompt refill of detergent and rinse agents.

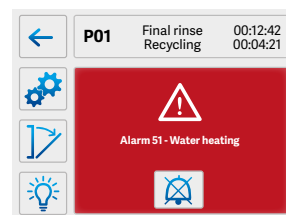

### Alarm Message.

The red Alarm Message screen confirms the reason for a system shutdown and prompts corrective action needed in advance of a restart.

# Comprehensive collection

– a perfect fit for any lab

## Superior efficiency for needs small and large.

Getinge Lancer Ultima offers a full range of labware washers to improve throughput. Undercounter washers offer a range of performance features designed to deliver clean labware faster than other industrial washers. Undercounter washers are available in three configurations and two sizes with generous load capacities.

### Getinge Lancer Ultima means superior quality

All models are produced to withstand harsh laboratory conditions, minimize water consumption and save energy. The complete line of Getinge Lancer Ultima labware

washers address applications at any capacity for high-density processing of multiple labware types.

All models feature the Prolux PLC microprocessor controller with color enhanced graphic user interface for intuitive one-touch cycle selection and start. The Prolux control functionality permits easy scale-up from smaller to larger models.

For more information on undercounter models please refer to the Getinge Lancer Ultima series undercounter brochure.

### Getinge Lancer Ultima series labware washers

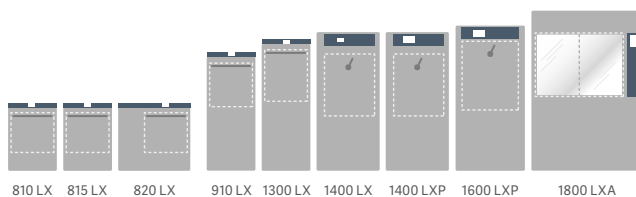

Getinge Lancer Ultima model 810 LX undercounter labware washer, shown with accessory loading racks, sold separately.



# Adaptable to suit your application

## Consumables

For best results, Getinge Lancer offers a selection of detergents and rinsing agents that have been tested and validated to maximize the performance of the Getinge Lancer Ultima washer while minimizing water consumption.

- Getinge Lancer LLL Detergent produces analytically clean results. It is phosphate free, fully biodegradable and will not harm aluminum, plastic or rubber.

A typical dose is from 6 to 10 ml per liter for water with hardness values between 200 and 400 ppm. Available in 10 liter container.

- The Getinge Lancer NLL Neutralizing agent is an acetic-acid based formulation ideal for the final rinse. The dose is typically 5 ml per liter. Available in 10 liter container.

## Some options available

Features		910 LX	1300 LX	1400 LX	1400 LXP	1600 LXP	1800 LXA
<b>Discharge water cooling</b>	Reduces effluent temperature to less than 60°C (140°F) for code compliant transfer to utility drain.	<input type="checkbox"/>	<input type="checkbox"/>	<input type="checkbox"/>	<input type="checkbox"/>	<input type="checkbox"/>	<input type="checkbox"/>
<b>pH programming</b>	Neutralizes effluent before transfer to utility drain.	<input type="checkbox"/>	<input type="checkbox"/>	<input type="checkbox"/>	<input type="checkbox"/>	<input type="checkbox"/>	<input type="checkbox"/>
<b>Printer</b>	For hard copy permanent record.	<input type="checkbox"/>	<input type="checkbox"/>	<input type="checkbox"/>	<input type="checkbox"/>	<input type="checkbox"/>	<input type="checkbox"/>
<b>Emergency Stop</b>	Emergency stop button.	<input type="checkbox"/>	<input type="checkbox"/>	<input type="checkbox"/>	<input type="checkbox"/>	<input type="checkbox"/>	<input checked="" type="checkbox"/>
<b>Sampling Valve</b>	Manual sampling valve.	<input type="checkbox"/>	<input type="checkbox"/>	<input type="checkbox"/>	<input type="checkbox"/>	<input type="checkbox"/>	<input type="checkbox"/>
<b>Conductivity monitoring</b>	Conductivity meter for final rinse verification.	<input type="checkbox"/>	<input type="checkbox"/>	<input type="checkbox"/>	<input type="checkbox"/>	<input type="checkbox"/>	<input type="checkbox"/>
<b>Pump pressure monitoring</b>	Verification that correct pump pressure is achieved in the water distribution system that secure optimal cleaning performance.	<input type="checkbox"/>	<input type="checkbox"/>	<input type="checkbox"/>	<input type="checkbox"/>	<input type="checkbox"/>	<input type="checkbox"/>
<b>Water softener</b>	Water softener.	<input type="checkbox"/>	<input type="checkbox"/>	<input type="checkbox"/>	<input type="checkbox"/>	<input type="checkbox"/>	<input type="checkbox"/>
<b>Chemical dosing pump, additional</b>	Additional chemical dosing pump. Up to 1 additional on 910 LX / 1300 LX / 1400 LX and up to 2 additional on 1400 LXP / 1600 LXP / 1800 LXA.	<input type="checkbox"/>	<input type="checkbox"/>	<input type="checkbox"/>	<input type="checkbox"/>	<input type="checkbox"/>	<input type="checkbox"/>
<b>Main Switch</b>	Main power switch, shuts off all power to the washer.	—	—	<input type="checkbox"/>	<input type="checkbox"/>	<input type="checkbox"/>	<input type="checkbox"/>

\* See product specifications for details and additional options to select.

■ / □ Standard / optional features

Utilities		910 LX	1300 LX	1400 LX	1400 LXP	1600 LXP	1800 LXA
<b>Steam heating</b>	Steam coil to utilize house steam for heating of wash/rinse water.	—	—	<input type="checkbox"/>	<input type="checkbox"/>	<input type="checkbox"/>	<input type="checkbox"/>
<b>Low pressure kit</b>	Boosts DI water supply input pressure to assure optimum performance.	<input type="checkbox"/>	<input type="checkbox"/>	<input type="checkbox"/>	<input type="checkbox"/>	<input type="checkbox"/>	<input type="checkbox"/>
<b>Steam condenser</b>	Steam condenser for collapsing exhaust vapor.	<input type="checkbox"/>	<input type="checkbox"/>	<input type="checkbox"/>	<input type="checkbox"/>	<input type="checkbox"/>	<input type="checkbox"/>
<b>Gravity drain</b>	For quick evacuation of chamber. Requires compressed air and floor drain.	—	—	—	<input type="checkbox"/>	<input type="checkbox"/>	<input type="checkbox"/>
<b>Tri-clamp DI inlet</b>	Direct DI water inlet with tri-clamp connection and dry contact for control of customer DI loop valve.	—	—	—	<input type="checkbox"/>	<input type="checkbox"/>	<input type="checkbox"/>

Construction		910 LX	1300 LX	1400 LX	1400 LXP	1600 LXP	1800 LXA
<b>Moving runners</b>	Customized location of rack manifolds to accommodate specific loads.	—	—	—	<input type="checkbox"/>	<input type="checkbox"/>	<input type="checkbox"/>
<b>Chamber height extension</b>	Chamber elevation extension; additional 250 mm (includes door jacks).	—	—	—	—	<input type="checkbox"/>	—
<b>Extended diptube kit</b>	Extended diptubes for use with 125-208 L (33-55 gal) chemical containers.	—	—	<input type="checkbox"/>	<input type="checkbox"/>	<input type="checkbox"/>	<input type="checkbox"/>
<b>Dry contact</b>	Dry contacts for external communication.	<input type="checkbox"/>	<input type="checkbox"/>	<input type="checkbox"/>	<input type="checkbox"/>	<input type="checkbox"/>	<input type="checkbox"/>
<b>Seismic restraints</b>	Seismic tie down brackets.	<input type="checkbox"/>	<input type="checkbox"/>	<input type="checkbox"/>	<input type="checkbox"/>	<input type="checkbox"/>	<input type="checkbox"/>
<b>Stainless steel plumbing</b>	Complete stainless steel hydraulic circuit including main circulation pump.	—	—	—	<input type="checkbox"/>	<input type="checkbox"/>	<input type="checkbox"/>
<b>View-In-Process window</b>	 Includes interior light, permitting visual verification during wash cycles.	<input type="checkbox"/>	<input type="checkbox"/>	<input type="checkbox"/>	<input type="checkbox"/>	<input type="checkbox"/>	<input type="checkbox"/>

\* See product specifications for details and additional options to select.

/  Standard / optional features

Site preparation	910 LX / 1300 LX / 1400 LX / 1400 LXP / 1600 LXP / 1800 LXA
<b>Water supply (hot, cold and DI)</b>	G ¾" hose thread connection, recommended min. flow 20 L/min (5.25 gpm); lower flow rates may extend cycle times; 200 to 600 kPa (29-87 psi) water pressure
<b>Drain requirement, vertical standpipe</b>	40 mm (1 ½") diameter, 500 to 700 mm (20" to 27") above floor

## Certifications

2006/42/EC

# Common accessories

Choose from up to 60 different injector racks, pipette racks and baskets. All racks are interchangeable between the washer lower and upper levels.

- A wide variety of standard inventory baskets and injector racks are available to meet most needs.
- Custom racks and baskets can be fabricated to meet specific needs or special applications.

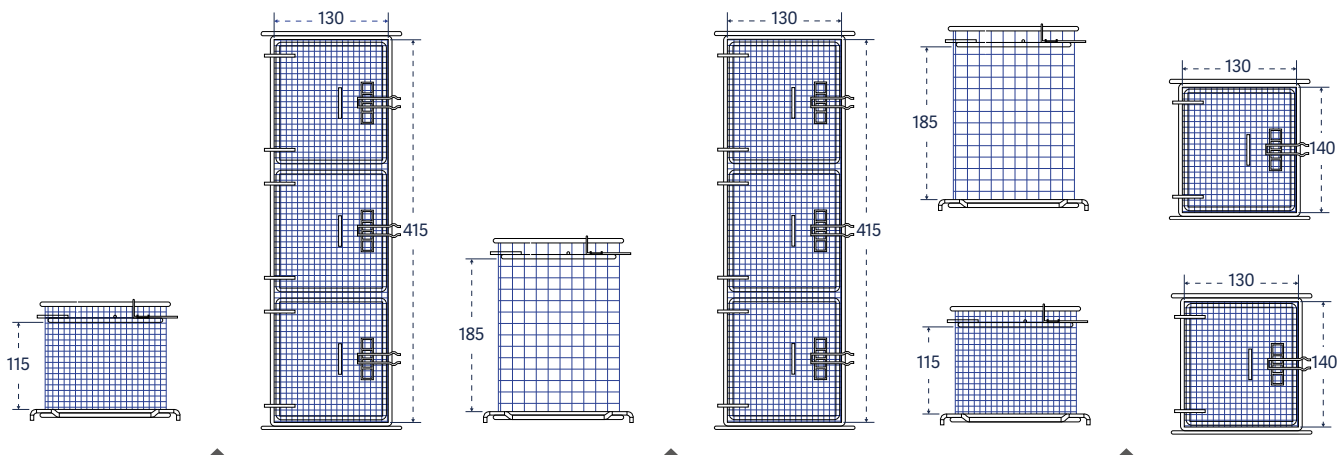

Small mesh basket with cover, long:  
Catalog No. STCXL



Small mesh basket, tall with cover, long:  
Catalog No. LTCXL



Small mesh baskets, tall and short:  
Catalog No. LTC and STC

Small mesh baskets	910 LX	1300 LX	1800 LX
For bottle caps, ferrules, plugs, stoppers and test tubes.			
Mesh basket, short, with cover, 122 x 134 x 93 mm	STC	STC	STC
Mesh basket, short, with cover, 122 x 409 x 93 mm	STCXL	STCXL	STCXL
Mesh basket, tall, with cover, 122 x 134 x 163 mm	LTC	LTC	LTC
Mesh basket, tall, with cover, 122 x 409 x 163 mm	LTCXL	LTCXL	LTCXL





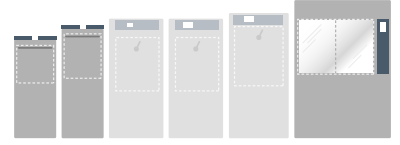

# Accessories

910 LX / 1300 LX / 1800 LXA



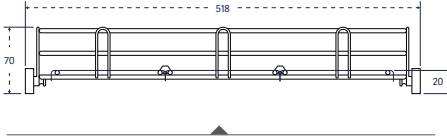

Basic basket with reversible tray lid:  
Catalog No. PST and GC



Basic basket with spray arm:  
Catalog No. PSBT



Basket for culture dishes: Catalog No. BP

### Baskets

Useful for beakers, trays, dishes, dissolution vessels, funnels, instruments and jars.

910 LX / 1300 LX / 1800 LX A

#### Basic basket

PST

#### Basic basket with spray arm

PSBT

#### Basket, half with spray arm

PSBT 1/2

#### Basket for culture dishes

BP

### Basket covers

Accessory basket covers are available to secure small or lightweight labware during the wash cycle.

910 LX / 1300 LX / 1800 LX A

#### Reversible tray lid for PST/PSBT

GC

#### Reversible tray lid, half size for PST/PSBT

GC1/2

#### Reversible tray lid, one-third size for PST/PSBT

GC1/3

#### Reversible tray lid for injector rack

GC

#### Reversible tray lid, half size for injector rack

GC1/2

#### Reversible tray lid, one-third size for injector rack

GC1/3



**Short injectors, 76 mm (3") tall**

For inside out cleaning of narrow neck glassware, bottles, cylinders, boiling flasks, Erlenmeyer flasks and volumetric flasks.

**910 LX / 1300 LX / 1800 LXA**

Half rack, 27 short jets, 6 mm diameter	27 IXC 1/2
36 short jets, 6 mm diameter	36 IXC
41 short jets, 6 mm BOD rack	41 IXC
48 short jets, 2 mm diameter	48 IXA
48 short jets, 6 mm diameter	48 IXC
64 short jets, 2 mm diameter	64 IXA
64 short jets, 6 mm diameter	64 IXC
64 short jets, mixed 2 mm and 6 mm diameter	64 IXA/2
100 short jets, 2 mm diameter	100 IXA
100 short jets, 6 mm diameter	100 IXC
100 short jets, mixed 2 mm and 6 mm diameter	100 IXA/2



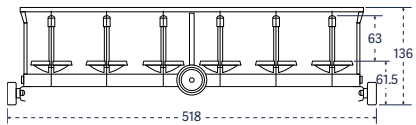
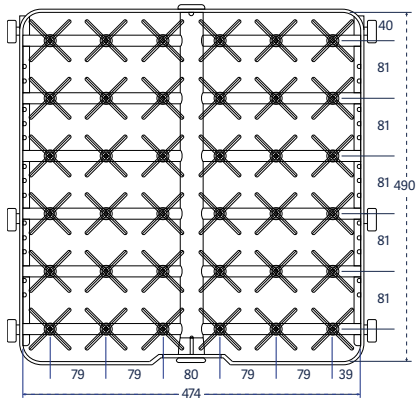

Catalog No. 36 IXC

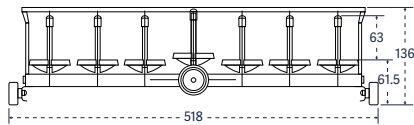
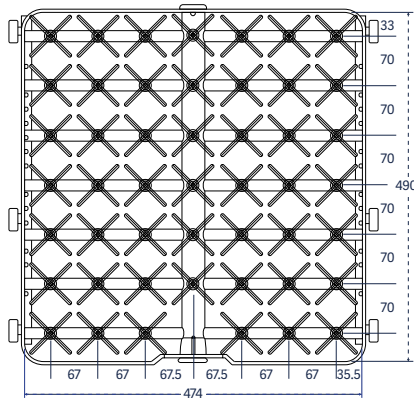

Catalog No. 48 IXC; IXA

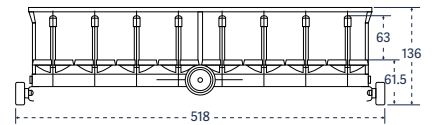
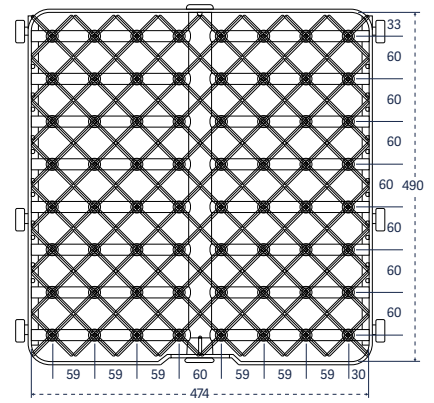

Catalog No. 64 IXA; IXC; IXA/2

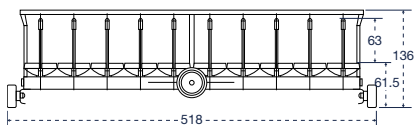
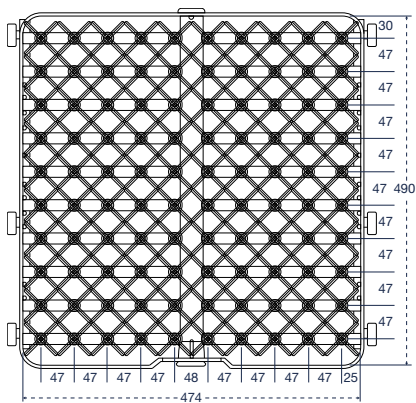

Catalog No. 100 IXA; IXC; IXA/2



IXC: Injector rack, short injectors, 76 mm (3") tall, jets 6 mm diameter



IXA: Injector rack, short injectors, 76 mm (3") tall, jets 2 mm diameter

**Long injectors, 152 mm (6") tall**  
 For inside out cleaning of large narrow neck glassware, bottles, cylinders, boiling flasks, Erlenmeyer flasks and volumetric flasks. **910 LX / 1300 LX / 1800 LXA**

<b>5 long jets, 12.7 mm diameter, with spray ball</b>	5 IXL
<b>9 long jets, 12.7 mm diameter</b>	9 IXL
<b>12 long jets, 6 mm diameter</b>	12 IXL
<b>20 long jets, 8 mm diameter</b>	20 IXL
<b>36 long jets, 6 mm diameter</b>	36 IXL
<b>48 long jets, 6 mm diameter</b>	48 IXL
<b>64 long jets, 6 mm diameter</b>	64 IXL
<b>100 long jets, 6 mm diameter</b>	100 IXL

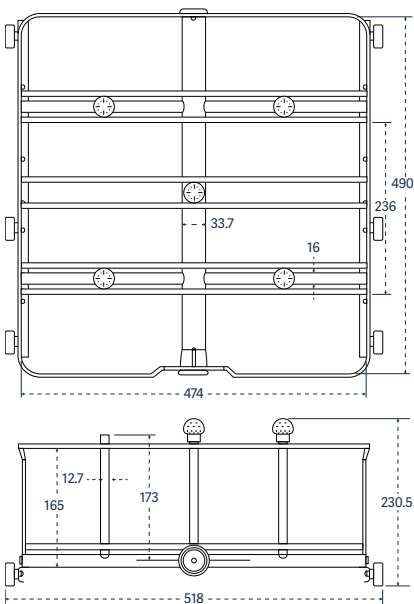

Catalog No. 5 IXL

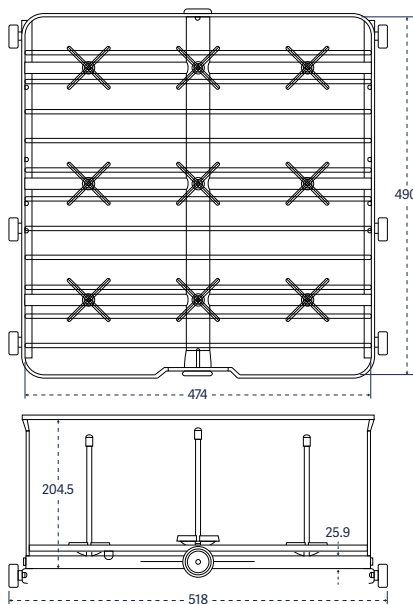

Catalog No. 9 IXL



Adjustable clip positions labware on injector for optimal cleaning performance.

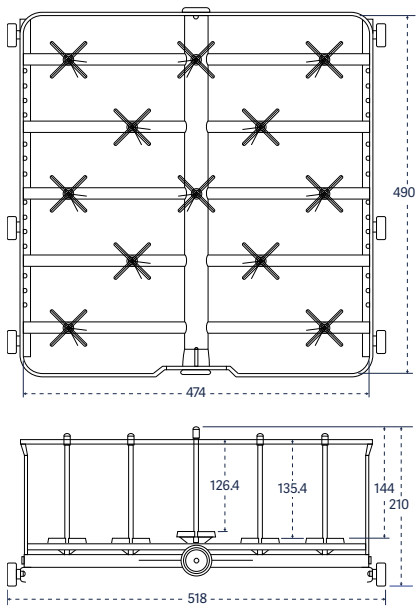

Catalog No. 12 IXL

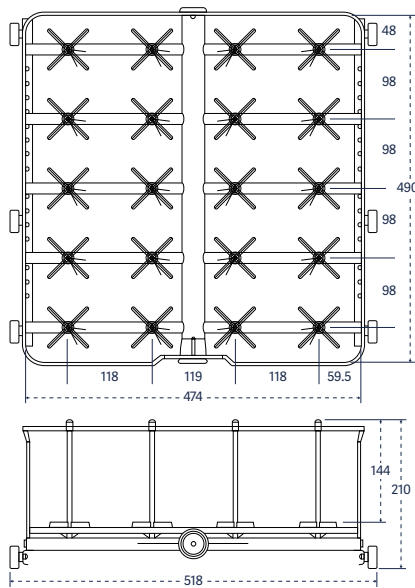

Catalog No. 20 IXL

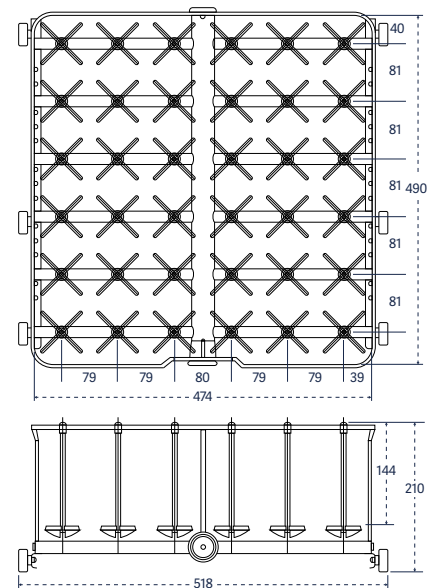

Catalog No. 36 IXL

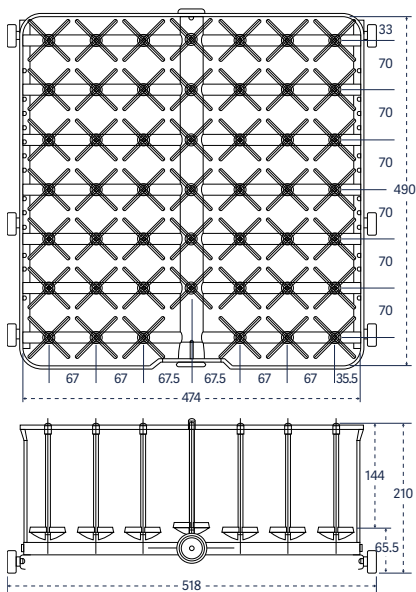

Catalog No. 48 IXL

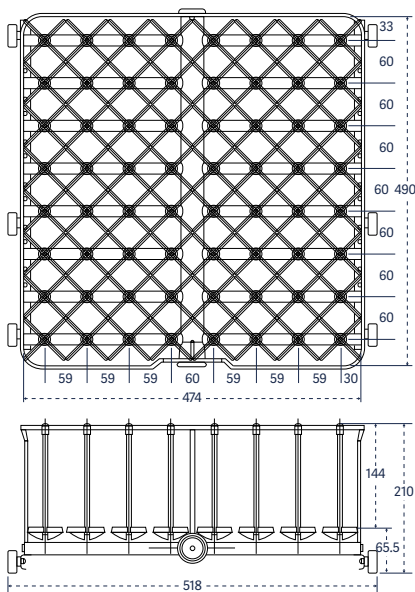

Catalog No. 64 IXL

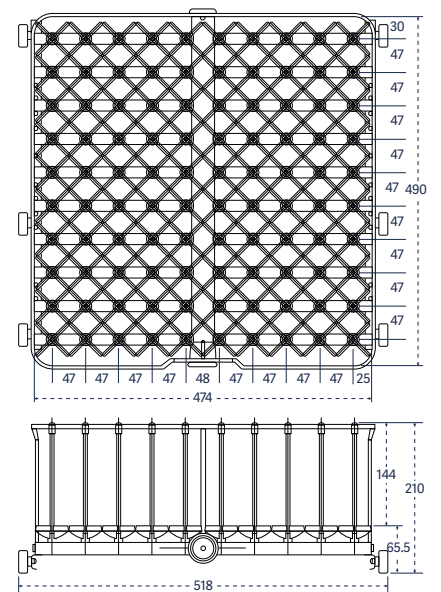

Catalog No. 100 IXL

### Injector rack covers

Injector rack covers are available to secure small or lightweight labware during the wash cycle.

910 LX / 1300 LX / 1800 LX A

Full-size	GCI
Half-size	GCI 1/2
Third-size	GCI 1/3

### Extra long injectors, 305 mm (12") tall

For inside out cleaning of narrow neck glassware, bottles, cylinders, boiling flasks, Erlenmeyer flasks and large volumetric flasks.

910 LX / 1300 LX / 1800 LX A

1 long jet, 12.7 mm diameter, with spray ball	1 IXL
2 long jets, 12.7 mm diameter, with spray ball	2 IXL
4 long jets, 12.7 mm diameter, with spray ball	4 IXL

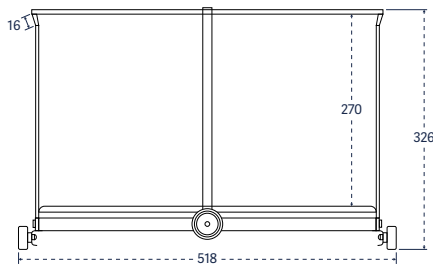
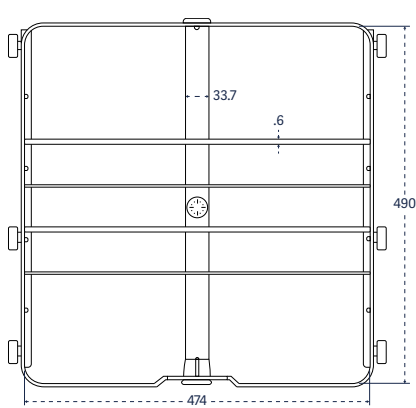

Catalog No. 1 IXL

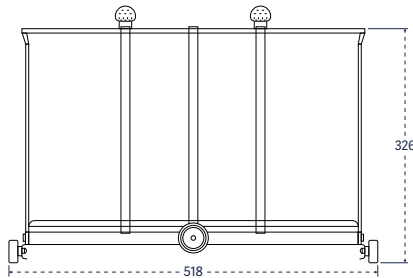
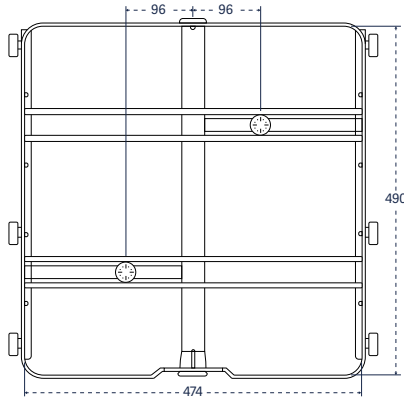

Catalog No. 2 IXL

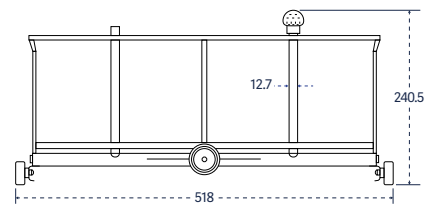
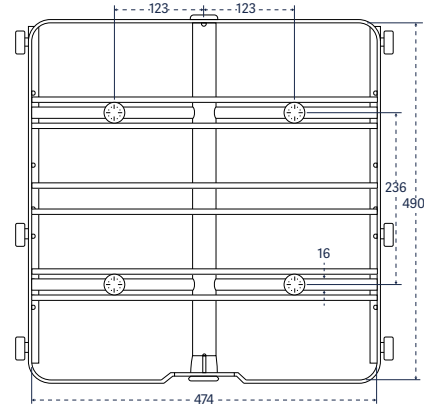

Catalog No. 4 IXL



### Combination short/long injectors

For inside out cleaning of mixed loads of narrow neck glassware, bottles, cylinders, boiling flasks, Erlenmeyer flasks and volumetric flasks.

910 LX / 1300 LX / 1800 LX A

36 short and long jets, 6 mm diameter	36 IXLC
48 short and long jets, 6 mm diameter	48 IXLC
48 short and long jets, 6 mm diameter, 2 rows 2 mm diameter	48 IXLCA
64 short and long jets, 6 mm diameter	64 IXLC
100 short and long jets, 6 mm diameter	100 IXLC

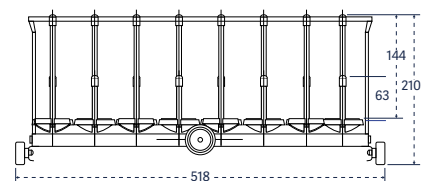
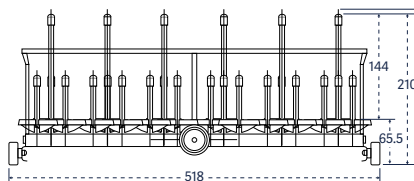
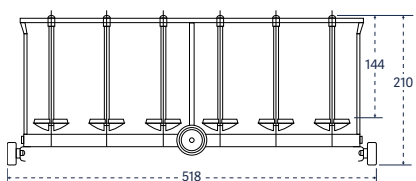
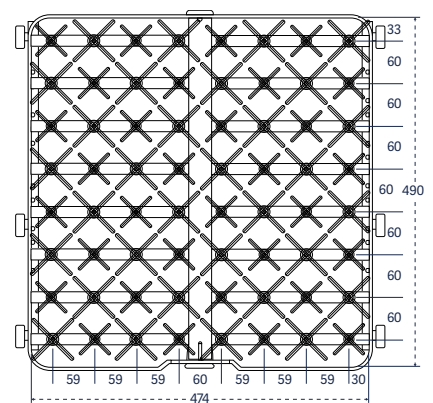
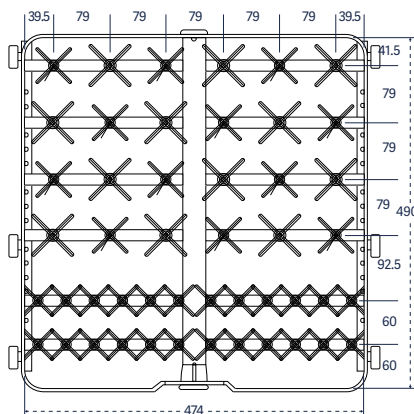
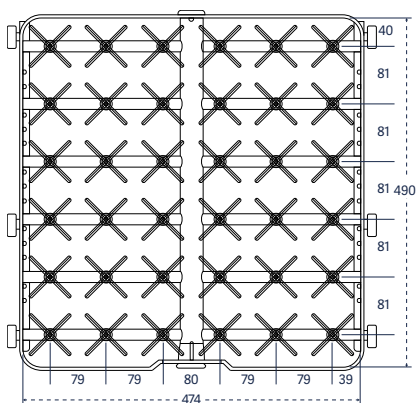

Catalog No. 36 IXLC

Catalog No. 48 IXLC; IXCLA

Catalog No. 64 IXLC

### Multipurpose racks

For a combination of labware and pipettes.

910 LX / 1300 LX / 1800 LX A

Basic basket plus 27 short and long jets

PS/27 IXLC

25 pipettes, angled plus 24 short and long jets

25 PIP/24 IXLC

50 pipettes, angled plus 34 short and long jets

50 PIP/34 IXLC

PST plus 14 short jets plus 4 long injectors, angled and perforated

4 EP/14 IXC/PS

28 short and long jets plus 4 long injectors, angled and perforated

4 EP/28 IXLC

One third PS plus 21 short and long jets, plus 25 pipettes

PS/21 IXLC/25 PIP

### Pipette racks

Accessory pipette racks are configured to accommodate reusable pipettes.

910 LX / 1300 LX / 1800 LX A

Grommet style, individually loaded, 100 position

100 PIP

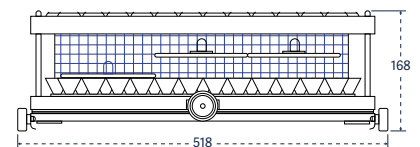
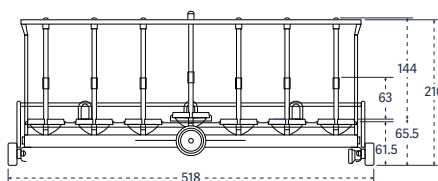
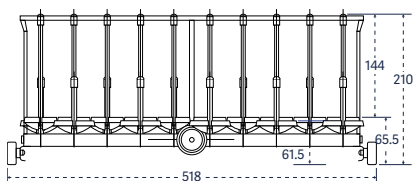
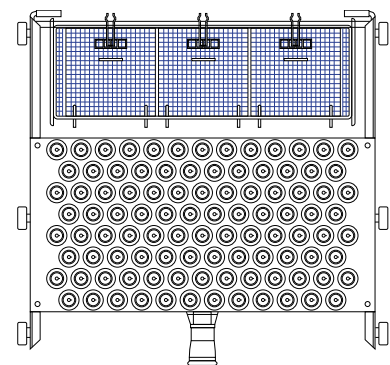
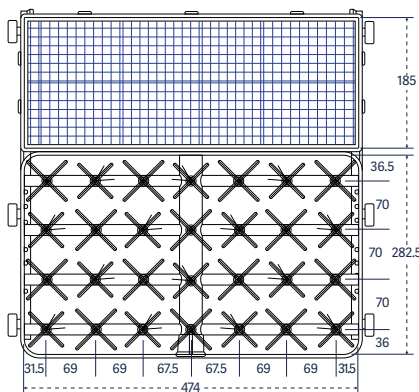
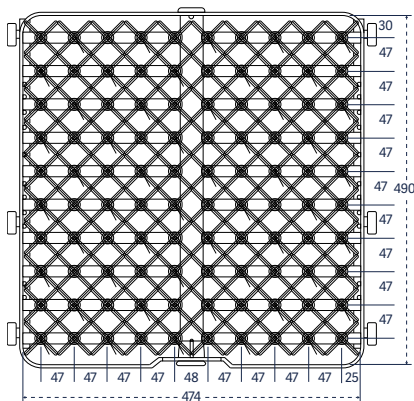

Catalog No. 100 IXLC

Catalog No. PS/27/IXLC

Catalog No. 100 PIP

**Storage stand**  
An accessory storage stand offers a convenient place to store accessory racks and baskets when not in use. **910 LX / 1300 LX / 1800 LX**

**Holds up to 5 racks** RP

**Supports**  
Stainless steel. Fits inside open basket to permit placement of load at an angle. **910 LX / 1300 LX / 1800 LX**

**Standard support, short, 3 1/2" (85 mm)** SSC

**Standard support, short, 1/3 PST surface** SSC 1/3 PS

**Standard support, tall, 6" (150 mm)** SSL

**Standard support, tall, 1/3 PST surface** SSL 1/3 PS

**Trolley**  
The stainless steel loading trolley transfers the load and mates with the washer to simplify loading and unloading. The trolley includes a retainer lip to keep the floor dry from residual water. Includes locking casters.

	<b>910 LX</b>	<b>1300 LX</b>	<b>1800 LX</b>
<b>Loading trolley</b>	TN 910 LX	TN 13	–
<b>Loading table</b>	–	–	TC 1800



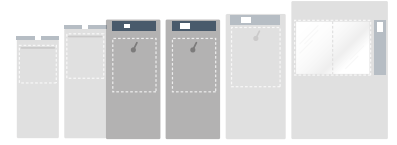

# Accessories

1400 LX / 1400 LXP



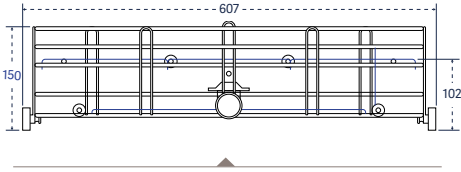

Basic basket with reversible tray lid:  
Catalog No. PST and GC



Basic basket with spray arm: Catalog No.  
PSBT



Basket for culture dishes: Catalog No. BP

### Baskets

Useful for beakers, trays, dishes, dissolution vessels, funnels, instruments and jars.

1400 LX / 1400 LXP

#### Basic basket

PST 14

#### Basic basket with spray arm

PSBT 14

#### Basket, half with spray arm

PSBT 1/2 14

#### Basket for culture dishes

BP 14

### Basket covers

Accessory basket covers are available to secure small or lightweight labware during the wash cycle.

1400 LX / 1400 LXP

#### Reversible tray lid for PST/PSBT

GC 14

#### Reversible tray lid, half size for PST/PSBT

GC 1/2 14

#### Reversible tray lid for injector rack

GCI 14

#### Reversible tray lid, half size for injector rack

GCI 1/2 14

**Short injectors, 76 mm (3") tall**

For inside out cleaning of narrow neck glassware, bottles, cylinders, boiling flasks, Erlenmeyer flasks and volumetric flasks.

**1400 LX / 1400 LXP**

<b>48 short jets, 6 mm diameter</b>	48 IXC 14
<b>64 short jets, 6 mm diameter</b>	64 IXC 14
<b>64 short jets, mixed 2 mm and 6 mm diameter</b>	64 IXA/2 14
<b>81 short jets, 6 mm diameter</b>	81 IXC 14
<b>81 short jets, 6 mm diameter</b>	81 IXC 14
<b>81 short jets, mixed 2 mm and 6 mm diameter</b>	81 IXA/2 14
<b>100 short jets, 2 mm diameter</b>	100 IXA 14
<b>100 short jets, 6 mm diameter</b>	100 IXC 14
<b>100 short jets, mixed 2 mm and 6 mm diameter</b>	100 IXA/2 14

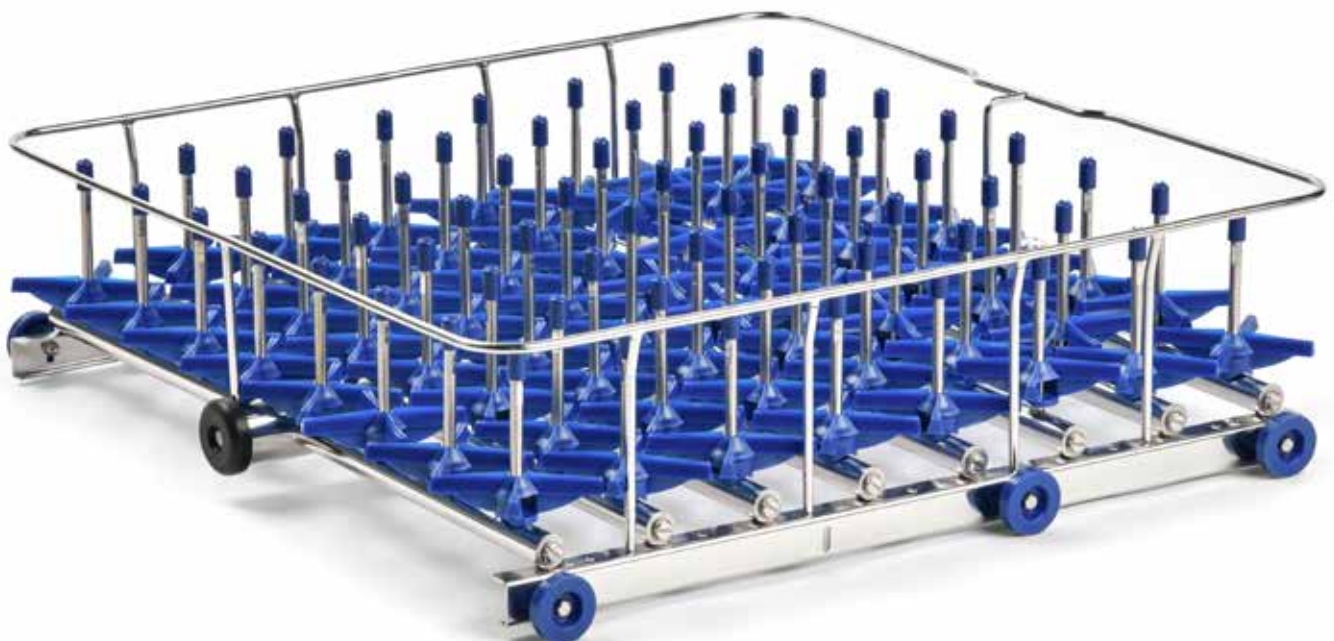

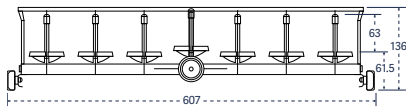
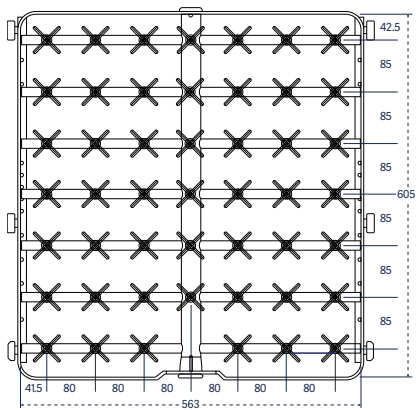

Catalog No. 48 IXC 14

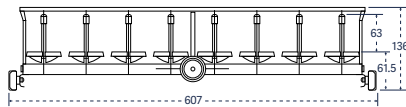
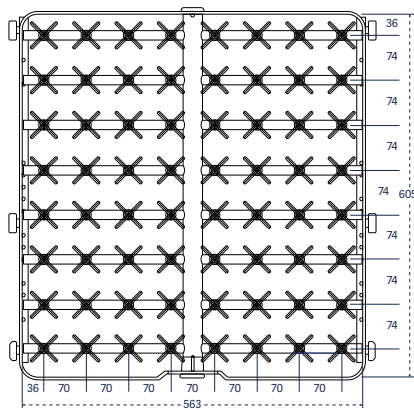

Catalog No. 64 IXC; IXA/2 14

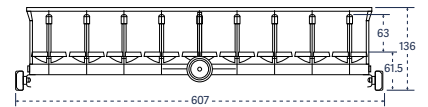
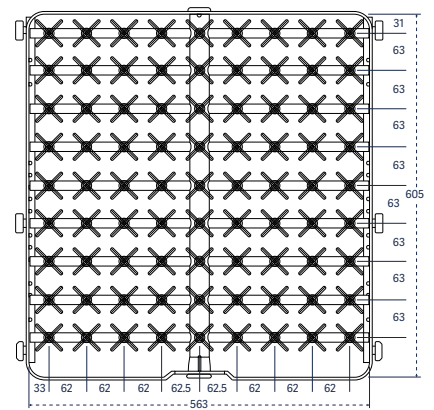

Catalog No. 81 IXA; IXC; IXA/2 14

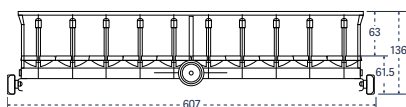
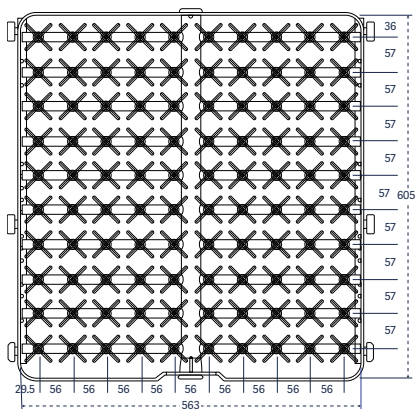

Catalog No. 100 IXA; IXC; IXA/2 14

**Long injectors, 152 mm (6") tall**

For inside out cleaning of large narrow neck glassware, bottles, cylinders, boiling flasks, Erlenmeyer flasks and volumetric flasks.

**1400 LX / 1400 LXP****9 long jets, 12.7 mm diameter**

9 IXL 14

**12 long jets, 6 mm diameter**

12 IXL 14

**24 long jets, 6 mm diameter**

20 IXL 14

**36 long jets, 6 mm diameter**

36 IXL 14

**48 long jets, 6 mm diameter**

48 IXL 14

**64 long jets, 6 mm diameter**

64 IXL 14

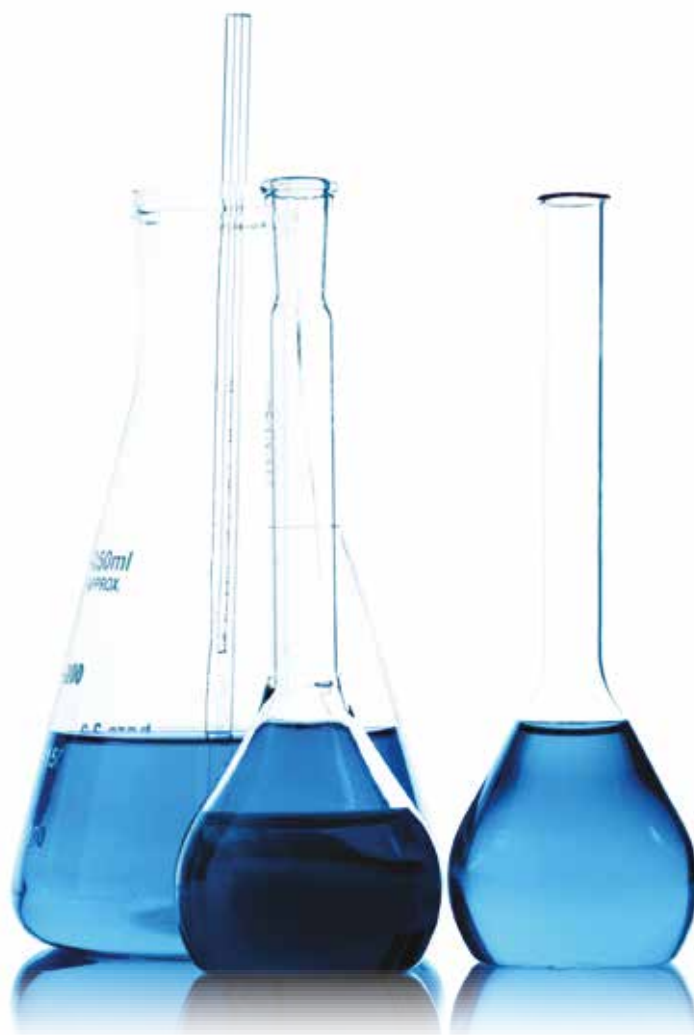



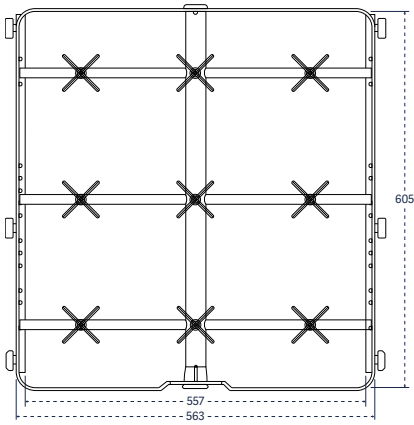

Catalog No. 9 IXL 14

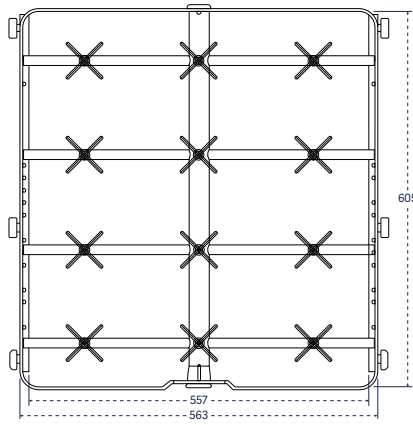

Catalog No. 12 IXL 14

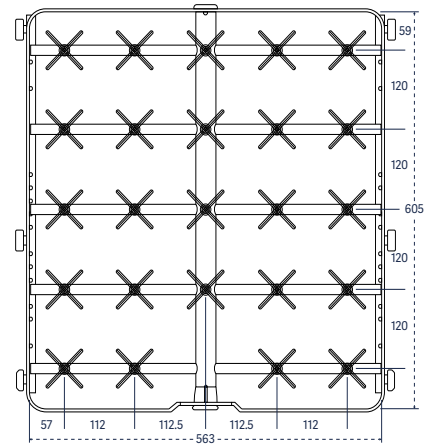

Catalog No. 24 IXL 14

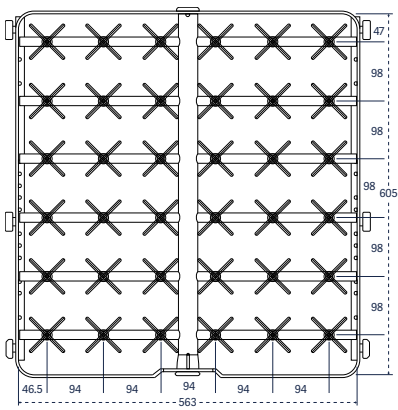
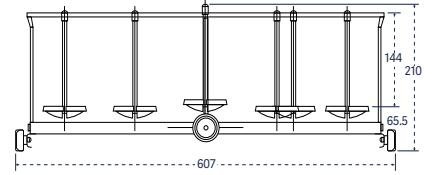
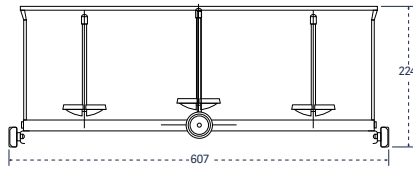
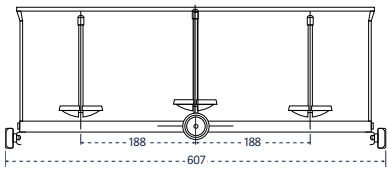

Catalog No. 36 IXL 14

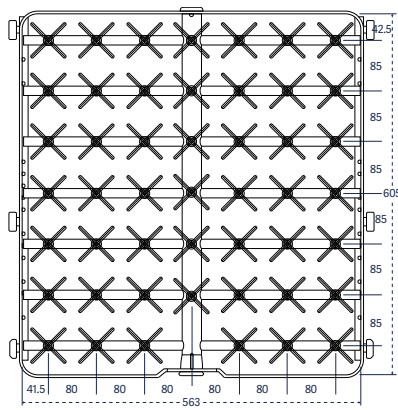

Catalog No. 48 IXL 14

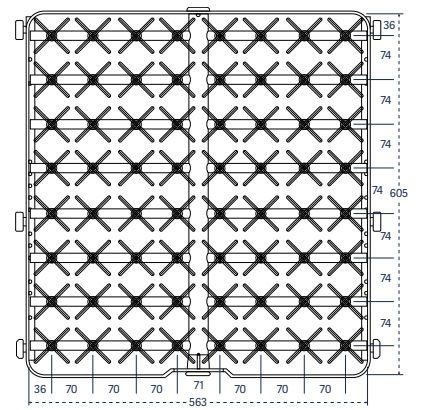

Catalog No. 64 IXL 14

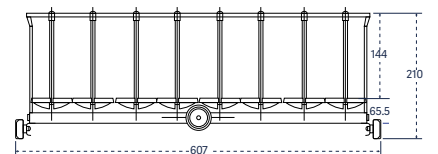
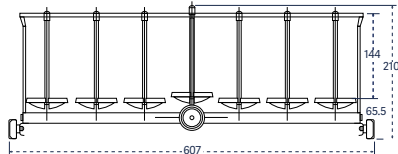
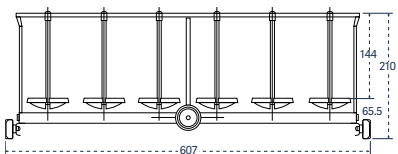

### Injector rack covers

Injector rack covers are available to secure small or lightweight labware during the wash cycle.

1400 LX / 1400 LXP

Full-size

GCI 14

Half-size

GCI 1/2 14

### Extra long injectors, 305 mm (12") tall

For inside out cleaning of narrow neck glassware, bottles, cylinders, boiling flasks, Erlenmeyer flasks and large volumetric flasks.

1400 LX / 1400 LXP

1 long jet, 12.7 mm diameter, with spray ball

1 IXL 14

2 long jets, 12.7 mm diameter, with spray ball

2 IXL 14

4 long jets, 12.7 mm diameter, with spray ball

4 IXL 14

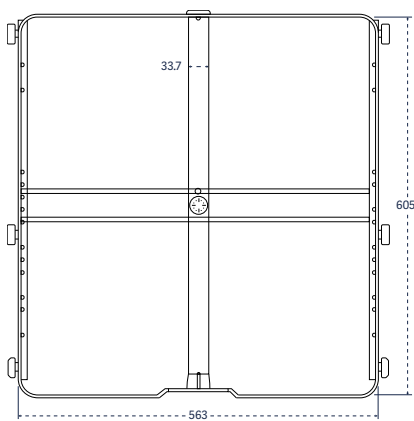

Catalog No. 1 IXL 14

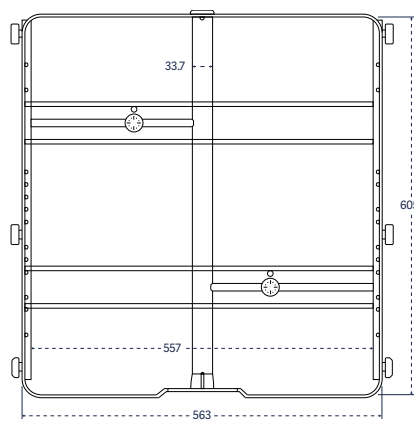

Catalog No. 2 IXL 14

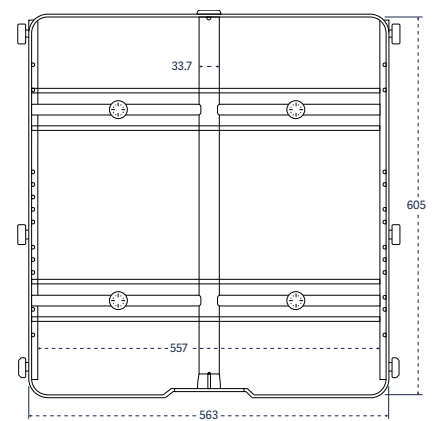

Catalog No. 4 IXL 14

### Combination short/long injectors

For inside out cleaning of mixed loads of narrow neck glassware, bottles, cylinders, boiling flasks, Erlenmeyer flasks and volumetric flasks.

1400 LX / 1400 LXP

36 short and long jets, 6 mm diameter

36 IXLC 14

48 short and long jets, 6 mm diameter

48 IXLC 14

64 short and long jets, 6 mm diameter

64 IXLC 14

81 short and long jets, 6 mm diameter

81 IXLC 14

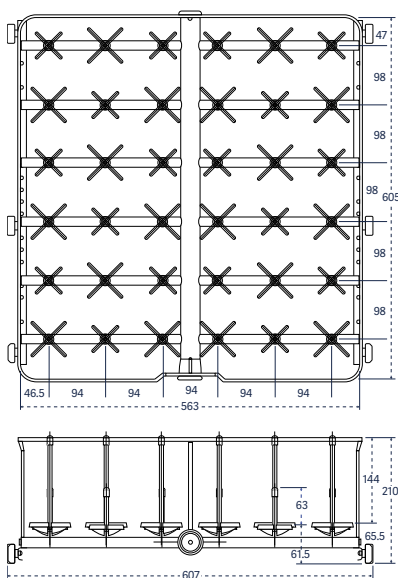

Catalog No. 36 IXLC 14

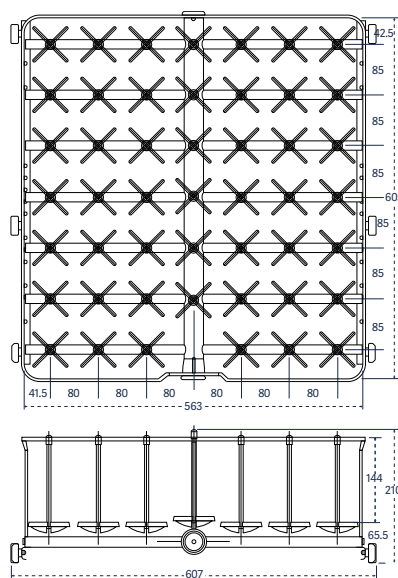

Catalog No. 48 IXL 14

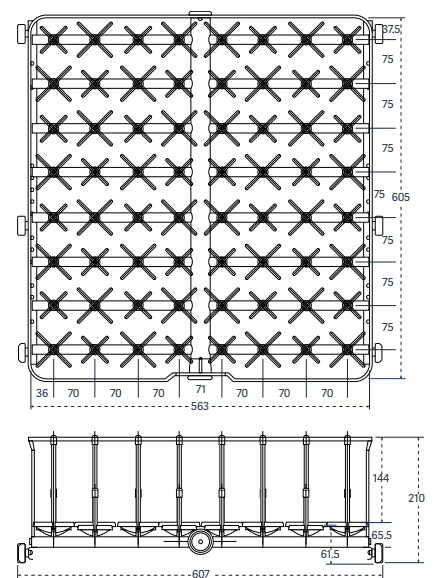

Catalog No. 64 IXLC 14

**Multipurpose racks**  
For a combination of labware and pipettes. **1400 LX / 1400 LXP**

<b>Basic basket plus 32 short and long jets</b>	PS/32 IXLC 14
<b>31 pipettes, angled plus 25 short and long jets</b>	31 PIP/25 IXLC 14
<b>24 short and long jets plus 4 long injectors, angled and perforated</b>	4 EP/24 IXLC 14

**Pipette racks**  
Accessory pipette racks are configured to accommodate reusable pipettes. **1400 LX / 1400 LXP**

<b>Grommet style, individually loaded, 124 position</b>	124 PIP 14
<b>Pipette rack, canisters (4)</b>	PPI 4B 14

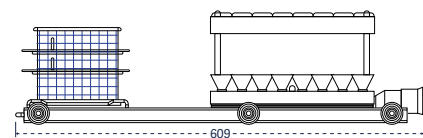
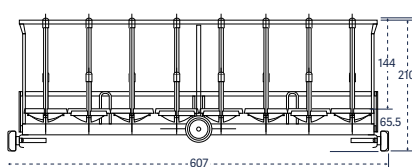
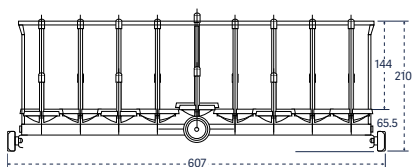
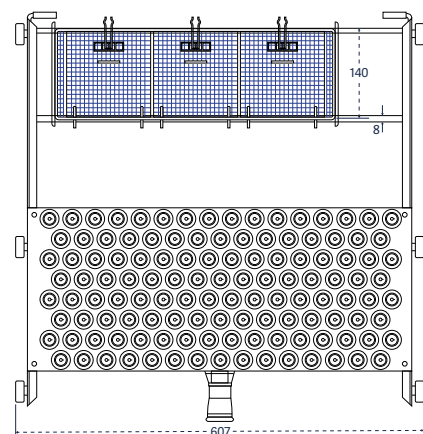
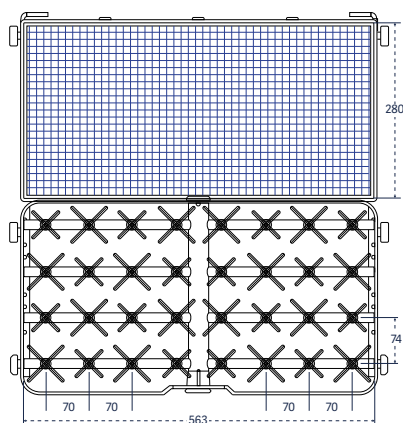
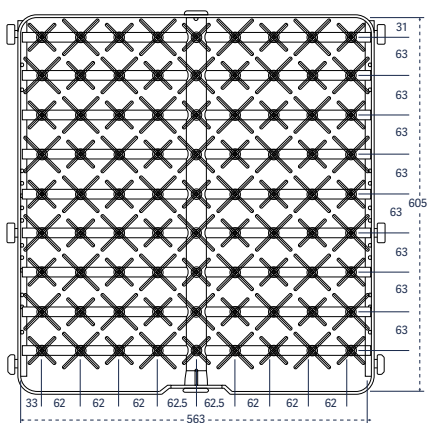

Catalog No. 81 IXLC 14

Catalog No. PS/32 IXLC 14

Catalog No. 124 PIP 14

### Storage stand

An accessory storage stand offers a convenient place to store accessory racks and baskets when not in use.

1400 LX / 1400 LXP

Holds up to 5 racks

RP 14

### Trolley

The stainless steel loading trolley transfers the load and mates with the washer to simplify loading and unloading. The trolley includes a retainer lip to keep the floor dry from residual water. Includes locking casters.

1400 LX / 1400 LXP

Trolley, 3 levels

TN 14

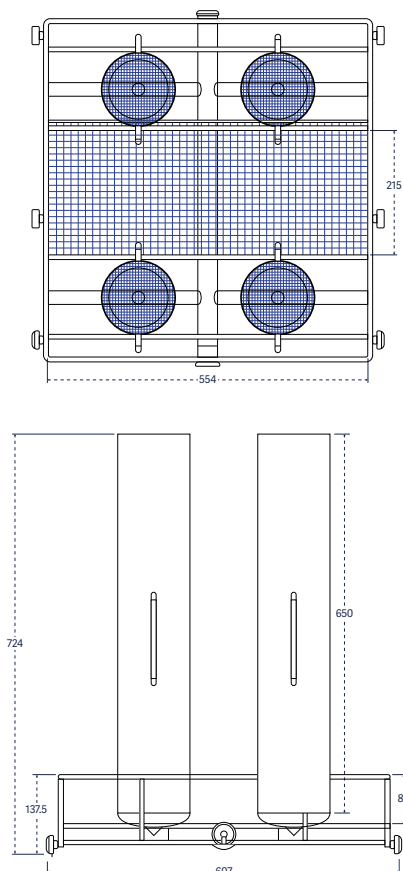

Catalog No. PPI 4B 14



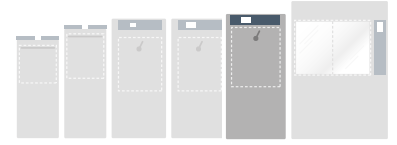

# Accessories

1600 LXP

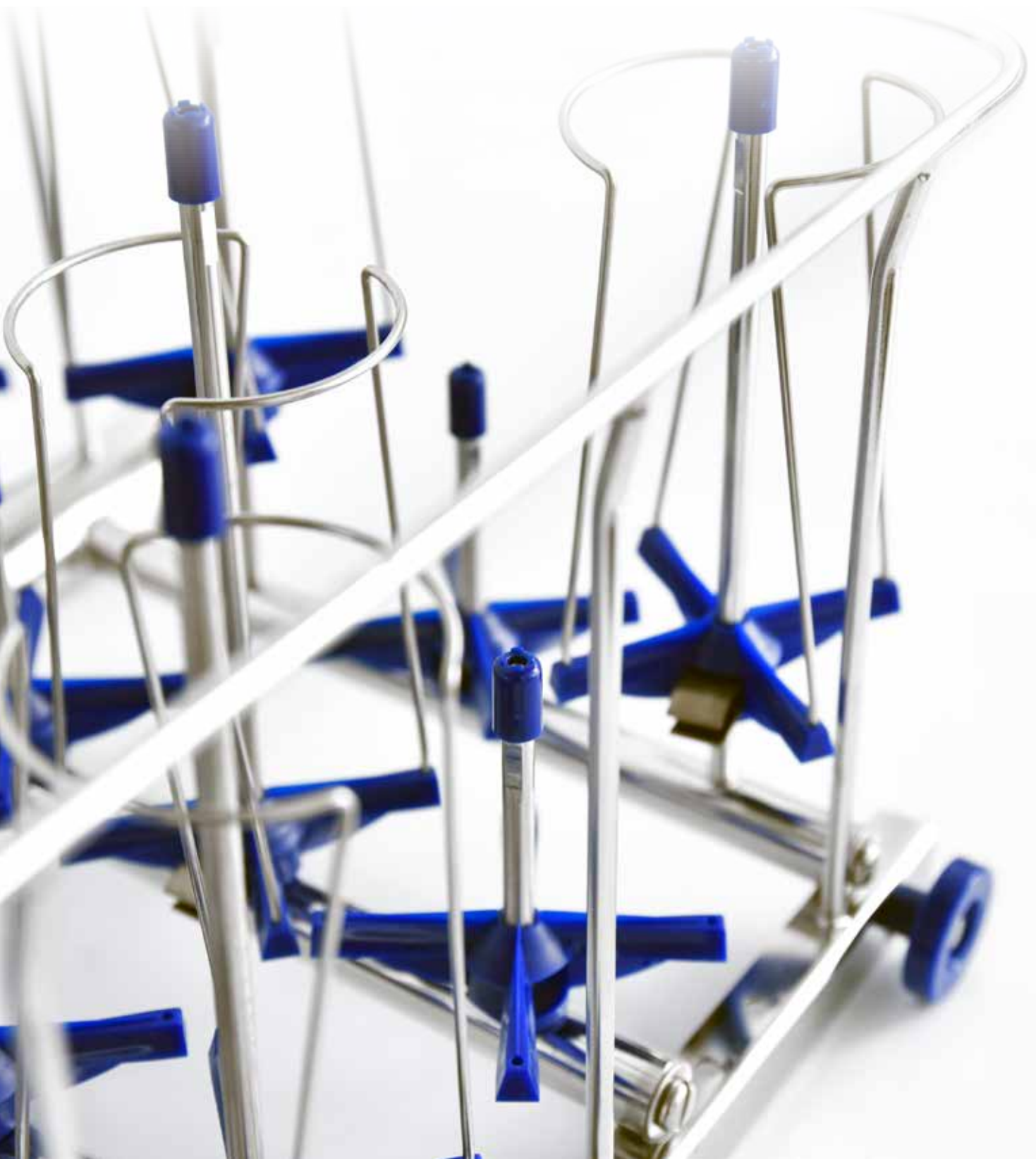

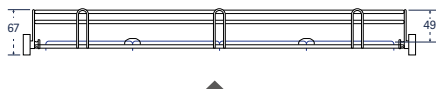

Basic basket with reversible tray lid:  
Catalog No. PST and GC



Basic basket with spray arm: Catalog No.  
PSBT



Basket for culture dishes: Catalog No. BP

**Baskets**  
Useful for beakers, trays, dishes, dissolution vessels, funnels, instruments and jars. **1600 LXP**

<b>Basic basket</b>	PST 16
<b>Basic basket with spray arm</b>	PSBT 16
<b>Basket for culture dishes</b>	BP 16

**Basket covers**  
Accessory basket covers are available to secure small or lightweight labware during the wash cycle. **1600 LXP**

<b>Reversible tray lid for PST/PSBT</b>	GC 16
<b>Reversible tray lid for injector racks</b>	GCI 16

**Short injectors, 76 mm (3") tall**

For inside out cleaning of narrow neck glassware, bottles, cylinders, boiling flasks, Erlenmeyer flasks and volumetric flasks.

**1600 LXP**

<b>36 short jets, 6 mm diameter</b>	36 IXC 16
<b>64 short jets, 6 mm diameter</b>	64 IXC 16
<b>80 short jets, 6 mm diameter</b>	80 IXC 16
<b>100 short jets, 2 mm diameter</b>	100 IXA 16
<b>100 short jets, 6 mm diameter</b>	100 IXC 16
<b>100 short jets, mixed 2 mm and 6 mm diameter</b>	100 IXA/2 16
<b>144 short jets, 2 mm diameter</b>	144 IXA 16
<b>144 short jets, 6 mm diameter</b>	144 IXC 16
<b>144 short jets, mixed 2 mm and 6 mm diameter</b>	144 IXA/2 16





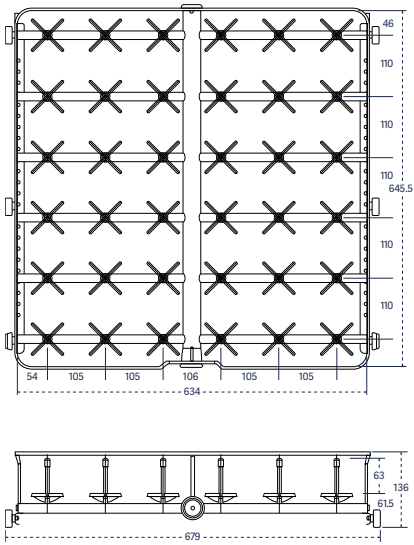

Catalog No. 36 IXC 16

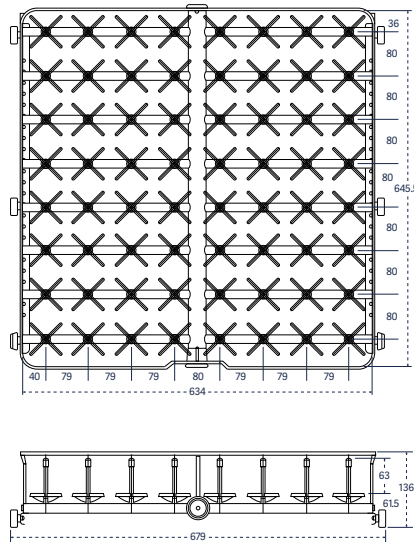

Catalog No. 64 IXC 16

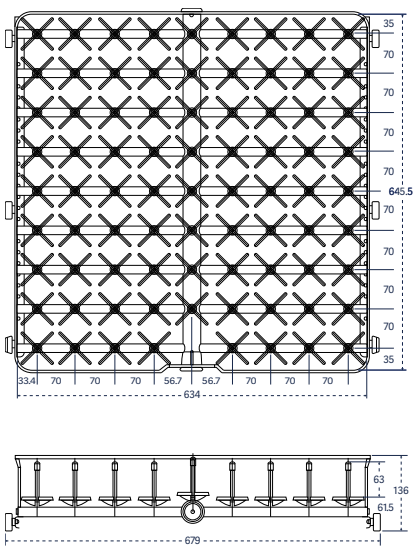

Catalog No. 80 IXC 16

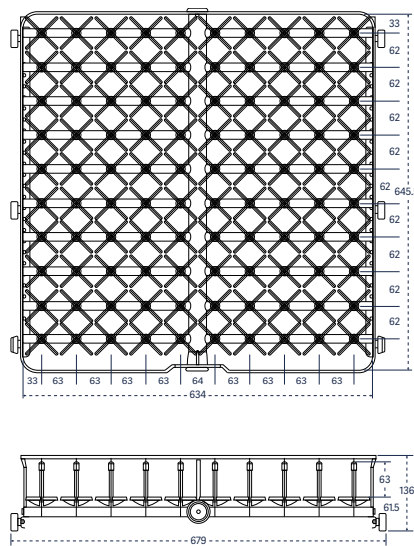

Catalog No. 100 IXA; IXC; IXA/2 16

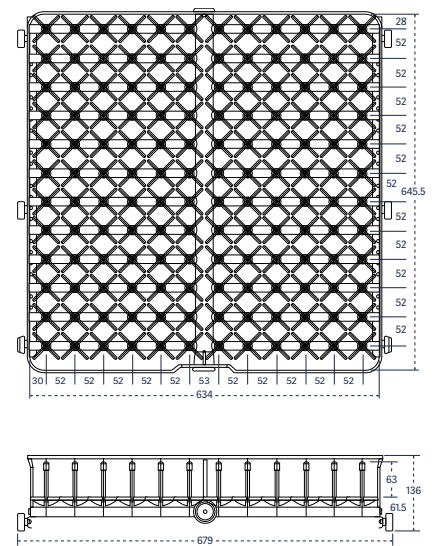

Catalog No. 144 IXA; IXC; IXA/2 16

**Long injectors, 152 mm (6") tall**

For inside out cleaning of large narrow neck glassware, bottles, cylinders, boiling flasks, Erlenmeyer flasks and volumetric flasks.

**1600 LXP**

**5 long jets, 12.7 mm diameter, with spray ball**

5 IXL 16

**9 long jets, 12.7 mm diameter**

9 IXL 16

**12 long jets, 6 mm diameter**

12 IXL 16

**36 long jets, 6 mm diameter**

36 IXL 16 D6

**36 long jets, 8 mm diameter**

36 IXL 16

**64 long jets, 6 mm diameter**

64 IXL 16

**80 long jets, 6 mm diameter**

80 IXL 16

**100 long jets, 6 mm diameter**

100 IXL 16

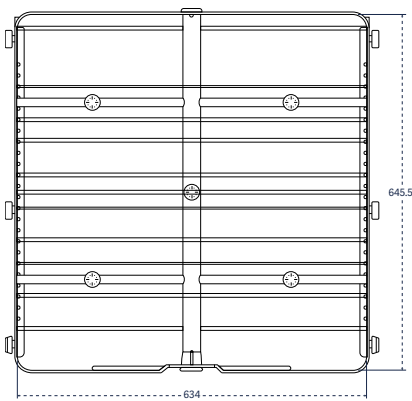

Catalog No. 5 IXL 16

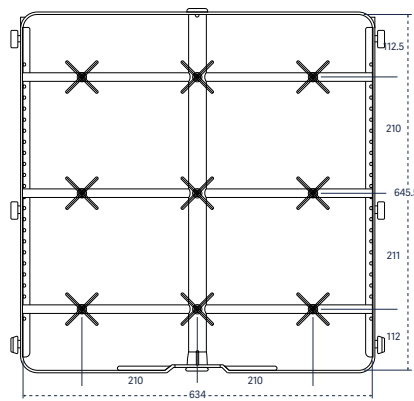

Catalog No. 9 IXL 16

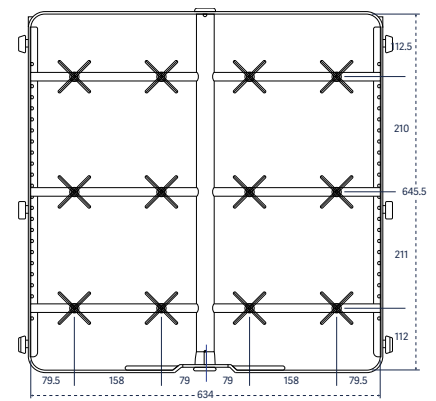

Catalog No. 12 IXL 16

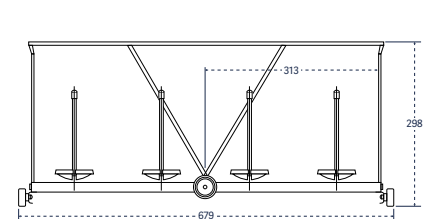
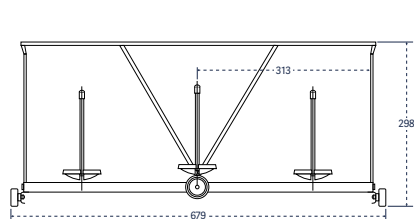
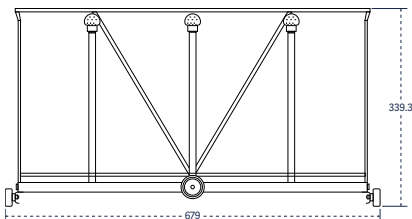

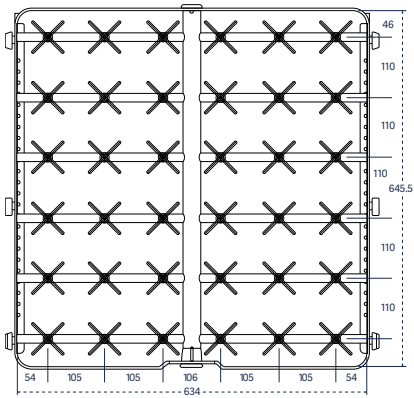

Catalog No. 36 IXL 16 D6

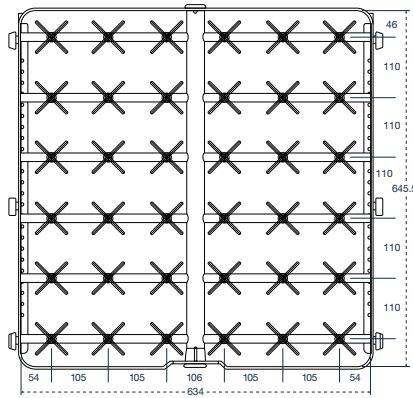

Catalog No. 36 IXL 16

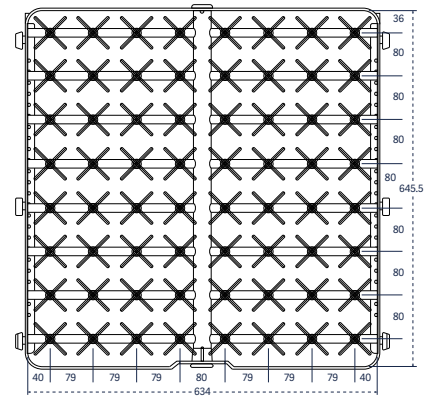

Catalog No. 64 IXL 16

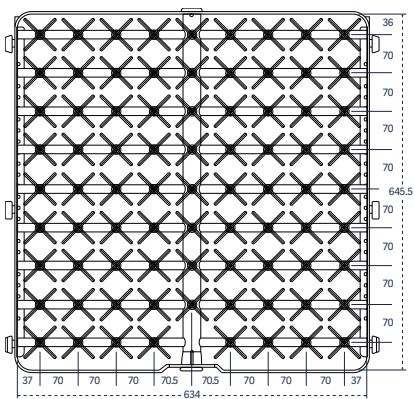
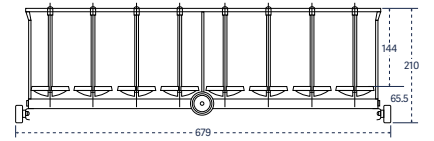
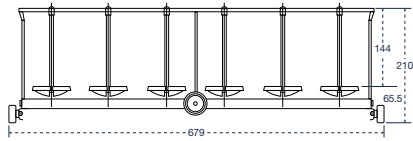
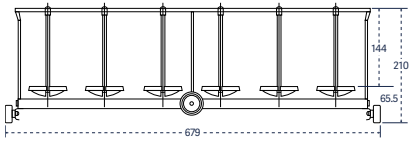

Catalog No. 80 IXL 16

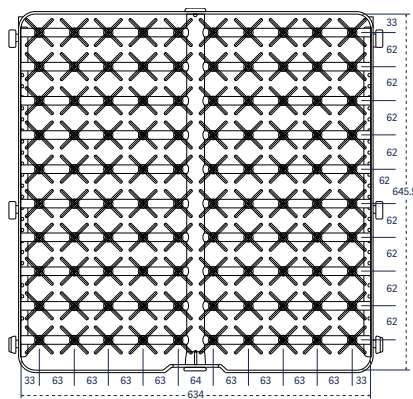

Catalog No. 100 IXL 16

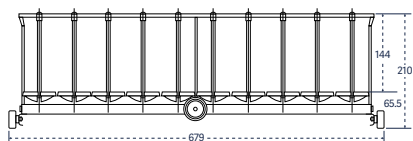
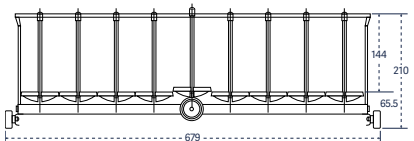

### Injector rack covers

Injector rack covers are available to secure small or lightweight labware during the wash cycle.

1600 LXP

Full-size

GCI 16

### Extra long injectors, 305 mm (12") tall

For inside out cleaning of narrow neck glassware, bottles, cylinders, boiling flasks, Erlenmeyer flasks and large volumetric flasks.

1600 LXP

1 long jet, 12.7 mm diameter, with spray ball

1 IXL 16

2 long jets, 12.7 mm diameter, with spray ball

2 IXL 16

4 long jets, 12.7 mm diameter, with spray ball

4 IXL 16

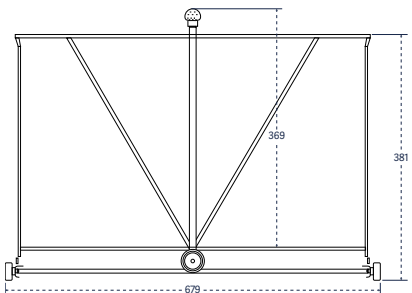
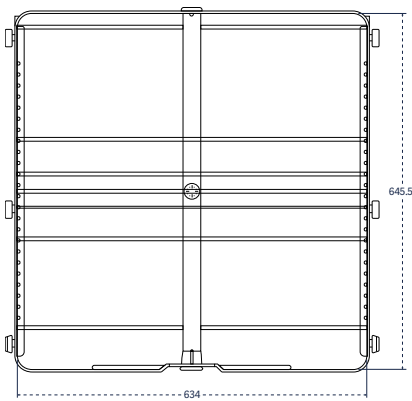

Catalog No. 1 IXL 16

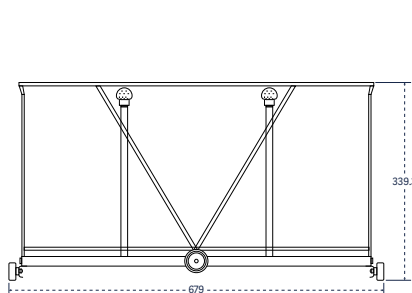
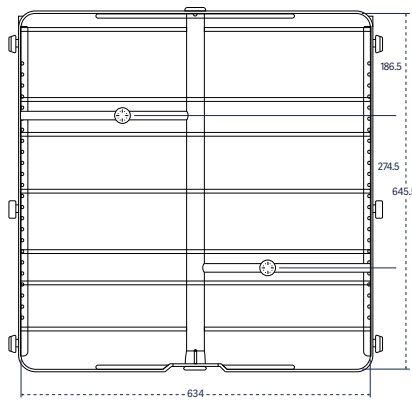

Catalog No. 2 IXL 16

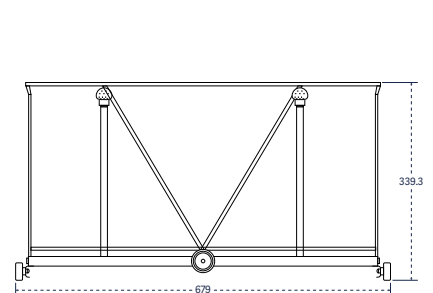
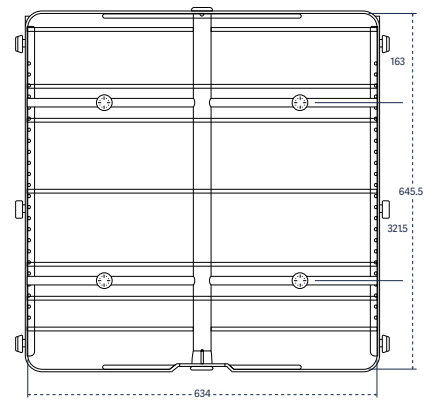

Catalog No. 4 IXL 16

### Combination short/long injectors

For inside out cleaning of mixed loads of narrow neck glassware, bottles, cylinders, boiling flasks, Erlenmeyer flasks and volumetric flasks.

1600 LXP

36 short and long jets, 6 mm diameter

36 IXLC 16

64 short and long jets, 6 mm diameter

64 IXLC 16

80 short and long jets, 6 mm diameter

80 IXLC 16

100 short and long jets, 6 mm diameter

100 IXLC 16

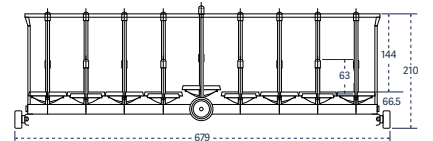
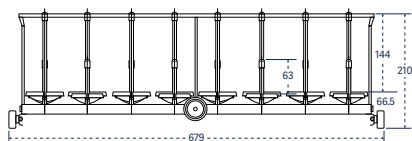
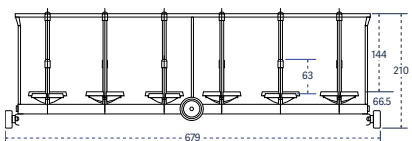
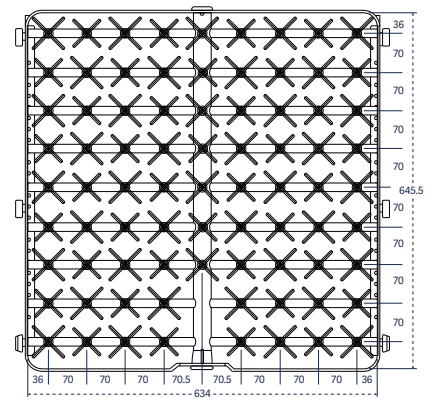
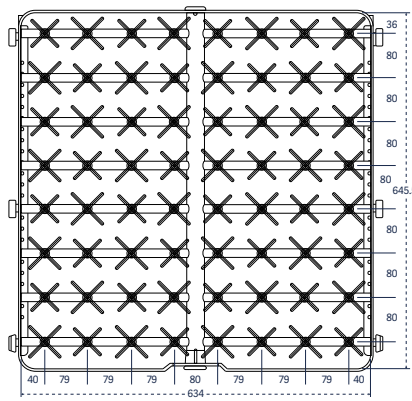
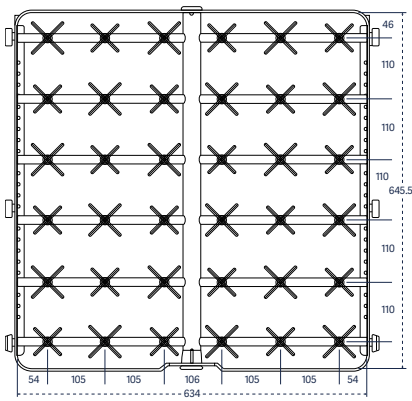

Catalog No. 36 IXLC 16

Catalog No. 64 IXLC 16

Catalog No. 80 IXLC 16

### Pipette racks

Accessory pipette racks are configured to accommodate reusable pipettes.

1600 LXP

Grommet style, individually loaded, 105 position

105 PIP 14

Grommet style, individually loaded, 210 position

210 PIP 16

### Storage stand

An accessory storage stand offers a convenient place to store accessory racks and baskets when not in use.

1600 LXP

Holds up to 5 racks

RP 16

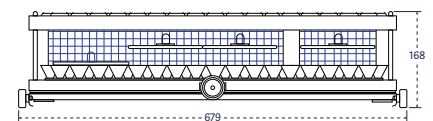
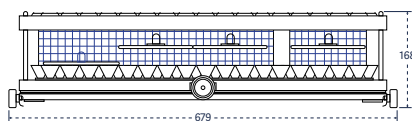
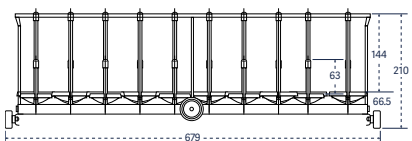
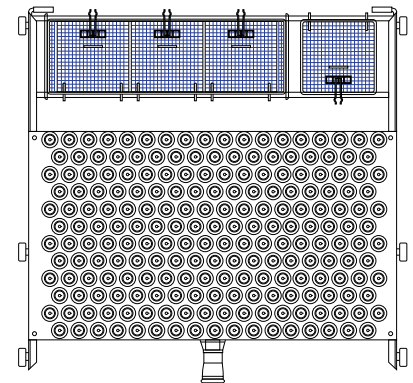
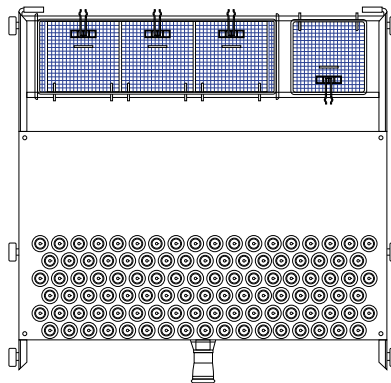
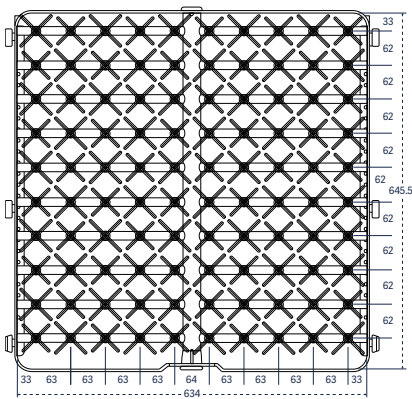

Catalog No. 100 IXLC 16

Catalog No. 105 PIP 16

Catalog No. 210 PIP 16

### Supports

Stainless steel. Fits inside open basket to permit placement of load at an angle.

1600 LXP

**Standard support, short, 3 1/2" (85 mm)**

SSC 16

**Standard support, short, 1/3 PST 16 surface**

SSC 1/3 PS 16

**Standard support, tall, 6" (150 mm)**

SSL 16

**Standard support, tall, 1/3 PST surface**

SSL 1/3 PS 16

### Trolley

The stainless steel loading trolley transfers the load and mates with the washer to simplify loading and unloading. The trolley includes a retainer lip to keep the floor dry from residual water. Includes locking casters.

1600 LXP

**Trolley, 4 levels**

TN 16

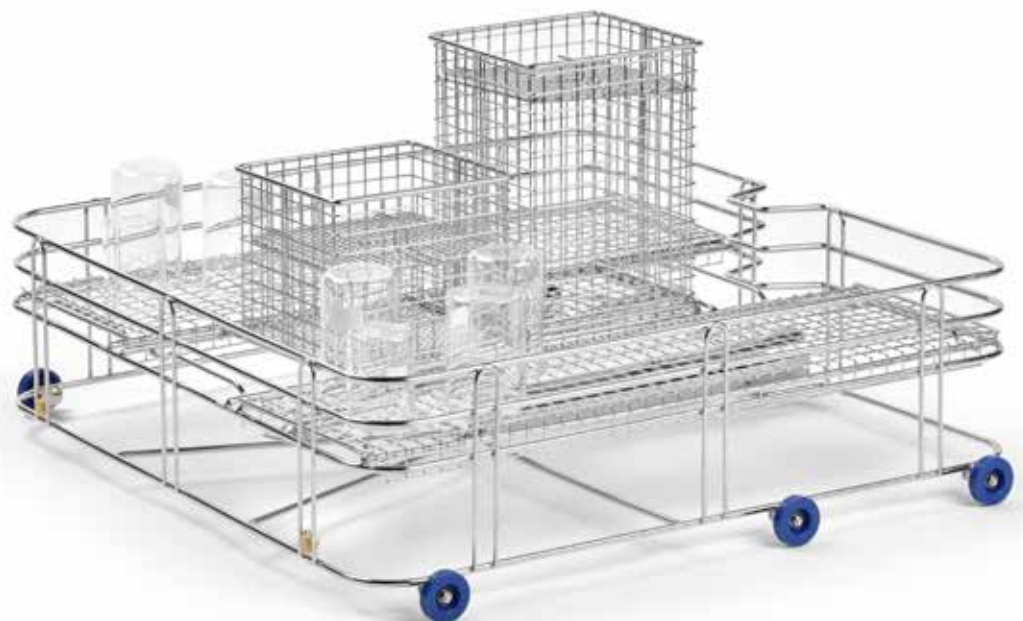



Getinge is a global provider of innovative solutions for Life Science companies and institutions, operating rooms, intensive care units and sterilization departments. Based on our firsthand experience and close partnerships with Life Science companies, clinical experts, healthcare professionals and medtech specialists, we are improving everyday life for people – today and tomorrow.

This document is intended to provide information to an international audience outside of the US.

**Getinge Infection Control AB · PO Box 69 · SE-305 05 Getinge · Sweden · +46 10 335 00 00 · [info@getinge.com](mailto:info@getinge.com)**

**[www.getinge.com](http://www.getinge.com)**